

The right choice for the ultimate yield!

LS ELECTRIC strives to maximize your profits in gratitude for choosing us as your partner.

Extension I/O Module

LSLV-S100 series

User's Manual

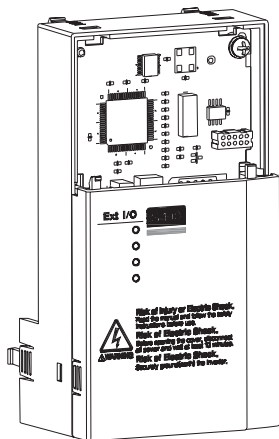

Safety Instructions

- Read this manual carefully before installing, wiring, operating, servicing or inspecting this equipment.
- Keep this manual within easy reach for quick reference.

LSELECTRIC

Thank you for purchasing S100 Series Extension I/O.

SAFETY PRECAUTIONS

- Always follow safety instructions to prevent accidents and potential hazards from occurring.
- Safety precautions are classified into “WARNING” and “CAUTION” and their meanings are as follows:

 **WARNING** Improper operation may result in serious personal injury or death.

 **CAUTION** Improper operation may result in slight to medium personal injury or property damage

- The indicated illustrations on the product and in the manual have the following meanings.

 Danger may be present. Read the message and follow the instructions carefully.

 Particular attention should be paid because danger of an electric shock may be present.

- Keep operating instructions handy for quick reference.
- Read the operating instructions carefully to fully understand the functions of the S100 series and to use it properly.

CAUTION

- **Be cautious, when handling the CMOS components of the communication module.**
Static may lead to malfunctioning of the product.
- **Turn off the inverter power, when changing the communication cable.**
Otherwise, you may damage the module or a communication error may occur.
- **Make sure to insert the Option board connector to the inverter precisely.**
Otherwise, you may damage the module or a communication error may occur.
- **Check the parameter unit before setting up the parameter.**
Otherwise, a communication error may occur.

Table of Contents

Chapter 1. Basic Information & Precautions	1
1.1 Characteristics.....	1
1.2 Components.....	1
Chapter 2. Specifications.....	2
2.1 External Dimension	2
2.2 Input and Output Specification.....	3
Chapter 3. Installation	4
3.1 Installation of S100 Extension I/O	4
3.2 Control Terminal Wiring.....	6
3.3 Signal (Control) Cable Specifications	8
Chapter 4. Basic Features	11
4.1 Basic function.....	11
4.2 Setting Frequency Reference.....	11
4.2.1 V3 Terminal as the Source.....	11
4.2.2 Setting a Frequency Reference with Input Voltage (Terminal I4).....	17
4.3 Analog Output	18
Voltage and Current Analog Output	18
4.4 Digital Output	20
4.4.1 Multi-function Output Terminal and Relay Settings	20
4.4.2 Fault Trip Output using Multi-Function Output Terminal and Relay.....	23
4.4.3 Multi-function Output Terminal Delay Time Settings	24
4.5 Setting Multi-step Frequency	25
4.6 Multi-step Acc/Dec Time Configuration	27
4.7 Stopping the Acc/Dec Operation.....	28
4.8 Multi-function Input Terminal Control.....	29
Chapter 5. Table of Functions	30
5.1 Operation Group	30
5.2 Drive group (PAR→dr).....	31
5.3 Basic Function group (PAR→bA)	35
5.4 Expanded Function group (PAR→Ad).....	38
5.5 Control Function group (PAR→Cn).....	43
5.6 Input Terminal Block Function group (PAR→In).....	47
5.7 Output Terminal Block Function group (PAR→OU).....	51
5.8 Communication Function group (PAR→CM)	55
5.9 Application Function group (PAR→AP)	59
5.10 Extension I/O Function Group(PAR→AO).....	61
5.11 Protection Function group (PAR→Pr).....	63
5.12 2nd Motor Function group (PAR→M2)	68
5.13 User Sequence group (US)	70
5.14 User Sequence Function group(UF)	72
5.15 Groups for LCD Keypad Only	88
5.15.1 Trip Mode (TRP Last-x).....	88
5.15.2 Config Mode (CNF).....	89

Chapter 1. Basic Information & Precautions

Before installation of S100 Extension I/O, this chapter explains basic information and precautions (The Extension I/O is supported by the product S/W V2.1 or higher.)

1.1 Characteristics

Additional terminals

- Digital Input : 3ea
- Digital Output : 2ea(1FormC)
- Analog Input : 2ea
- Analog Output : 1ea

1.2 Components

S100 Extension I/O consists of following items.

- S100 Extension I/O : 1ea
- User manual : 1ea
- Brass supporter(M3xL17.3) : 1ea
- Brass supporter(M3xL23) : 1ea
- Screw(M3xL8) : 2ea
- Other parts

If you find damaged or missing parts, please contact LS ELECTRIC office(refer to the end of this manual).

Chapter 2. Specifications

2.1 External Dimension

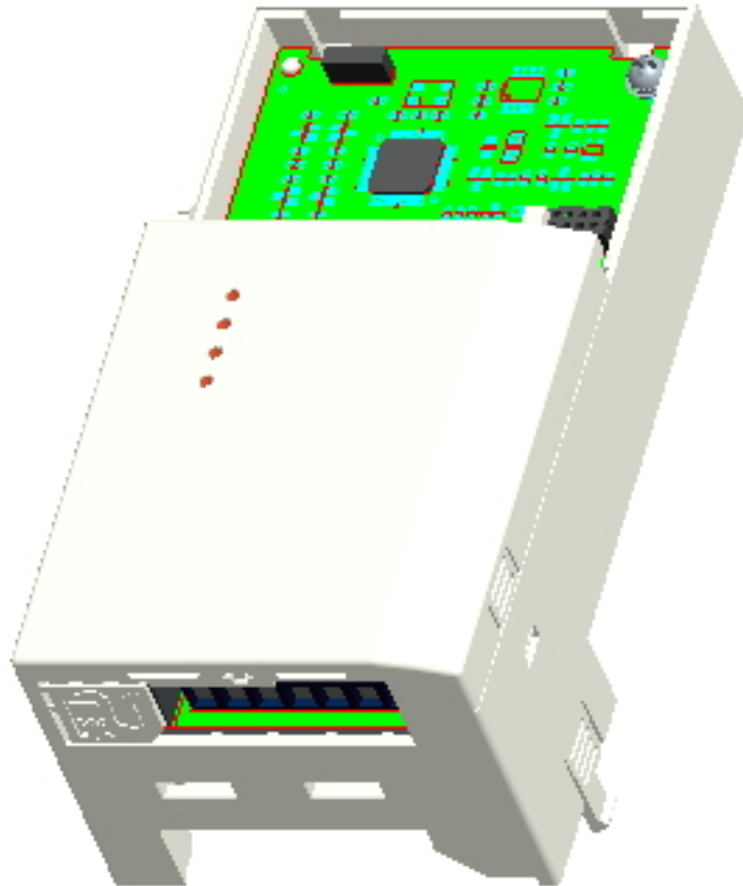

2.2 Input and Output Specification

Function		Label	Name	Description
IN PUT	Multi-function terminal configuration	P8 ~ P10	Multi-function Input 8~10	Configurable for multi-function input terminals.
		CM	Common Sequence	Common terminal for analog terminal inputs and outputs.
	Analog input configuration	V3	Voltage input for frequency reference input	Used to setup or modify a frequency reference via analog voltage input terminal. <ul style="list-style-type: none"> • Unipolar: 0–10V (12V Max.) • Bipolar: -10–10V (±12V Max.)
		I4	Voltage/current input for frequency reference input	Used to setup or modify a frequency reference via analog voltage or current input terminals. Switch between voltage (V4) and current (I4) modes using a control board switch (SW2). V4 Mode: <ul style="list-style-type: none"> • Unipolar: 0–10V (12V Max.) I4 Mode <ul style="list-style-type: none"> • Input current: 4–20mA • Maximum Input current: 24mA • Input resistance: 249Ω
OUT PUT	Analog Output	AO3	Voltage/Current Output	devices: output frequency, output current, output voltage, or a DC voltage. Operate switch (SW3) to select the signal output type (voltage or current) at the AO terminal. Output Signal Specifications: <ul style="list-style-type: none"> • Output voltage: 0–10V • Maximum output voltage/current: 12V/10mA • Output current: 0–20mA • Maximum output current: 24mA • Factory default output: Frequency
	Digital Output	CM	Common Sequence	Common terminal for analog terminal inputs and outputs.
		A3, C3, B4	Fault signal output	Sends out alarm signals when the inverter's safety features are activated (AC 250V < 1A, DC 30V < 1A). Fault condition: A3 and C3 contacts are connected (B3 and C3 open connection) Normal operation: B3 and C3 contacts are connected (A3 and C3 open connection)
	A4, C4, B4	Fault signal output	Sends out alarm signals when the inverter's safety features are activated (AC 250V < 1A, DC 30V < 1A). Fault condition: A4 and C3 contacts are connected (B4 and C4 open connection) Normal operation: B4 and C4 contacts are connected (A4 and C4 open connection)	

Chapter 3. Installation

3.1 Installation of S100 Extension I/O

Warning) Connect a communication network after the power supply of the S100 inverter must be off.
If the power supply is plugged when Extension I/O is removed, the S100 inverter will be damaged entirely.
Take off Extension I/O from the product after the power supply is totally discharged.

In case of LSLV0004S100-2EXNNS, LSLV0008S100-2EXNNS, LSLV0004S100-4EXFNS, LSLV0008S100-4EXFNS, it is impossible to do wiring of main source after assembly of Extension I/O. Please assemble Extension I/O after wiring of main source. If you need to using built-in I/O terminals, please do wiring of the terminals before assembly of extension I/O

- Take off the power supply cover and the I/O cover((1), (2)) from a dedicated S100 inverter for communication.

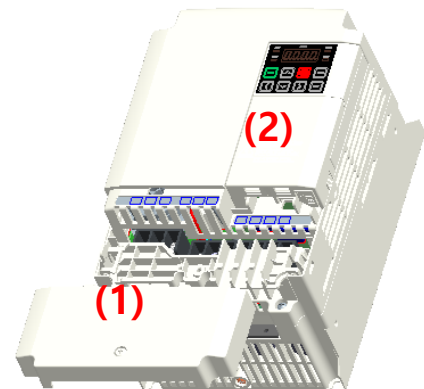

- Take off the keypad (3).

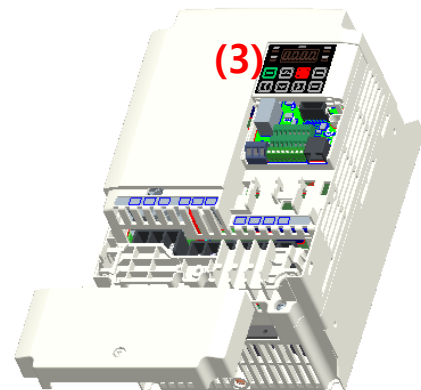

- Loosen a screw from the I/O board and fasten the prepared brass bar (M3xL23) to (4), and (M3xL17.3) to (5).

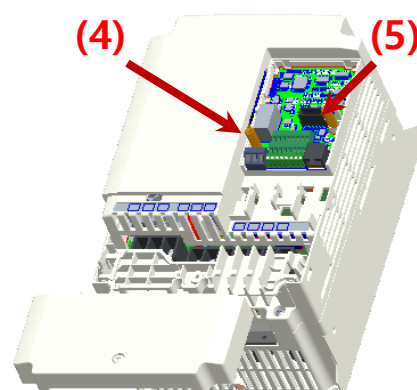

- Mount the Extension I/O(6) and fasten the removed screw(7) and the included screw(8).

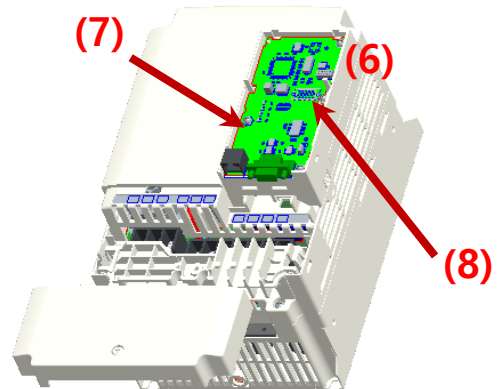

- Install the keypad (9) at first and the Extension I/O cover(10) in order.

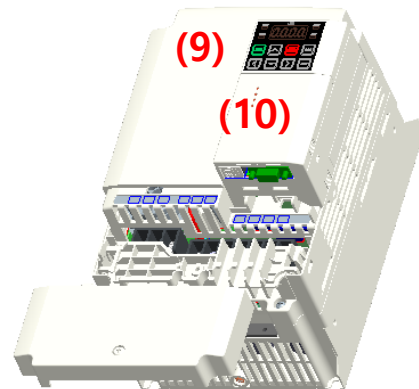

- Install the power supply cover(11) again
And the installation is completed.

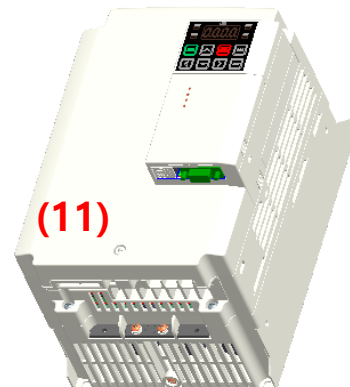

3.2 Control Terminal Wiring

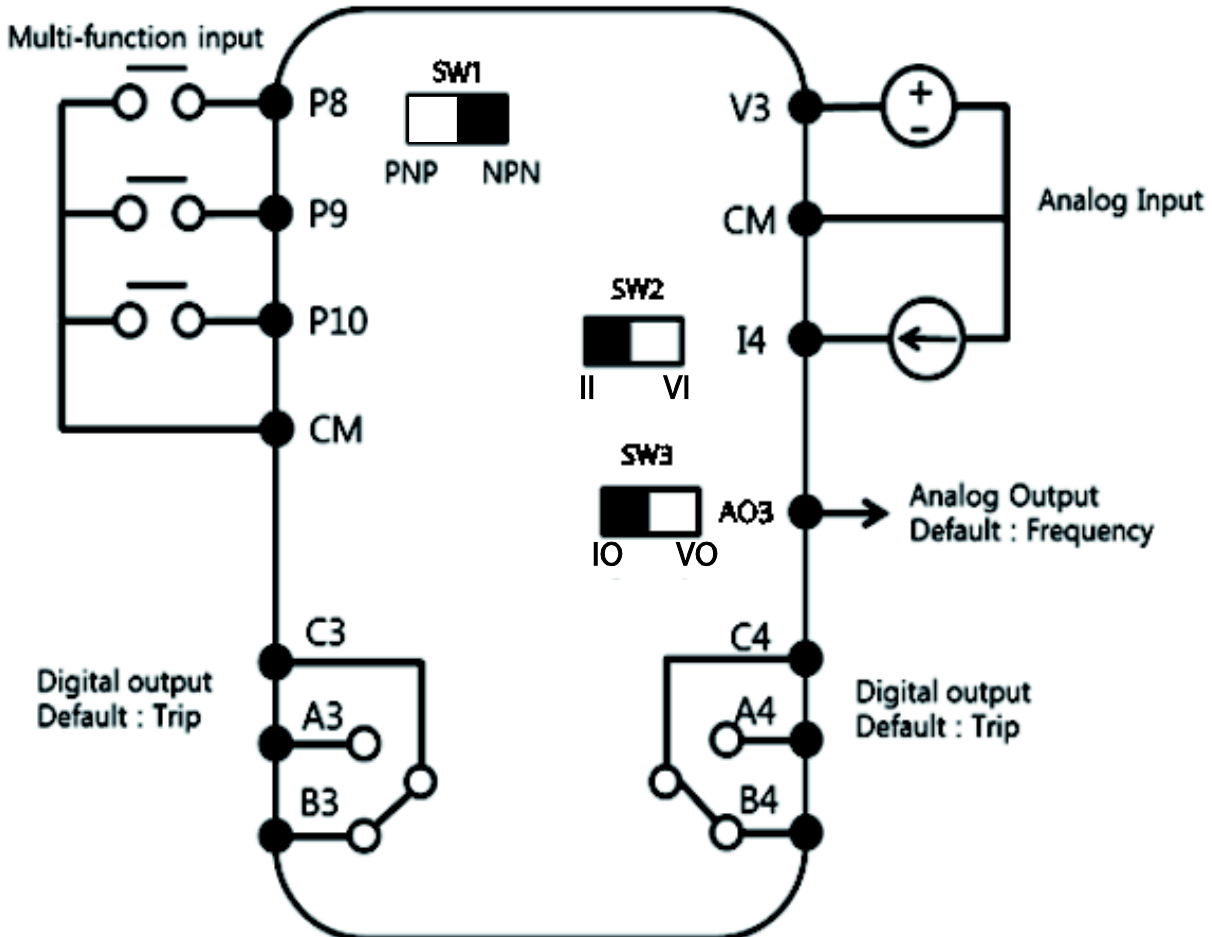

■ NPN(Sink)/PNP(Source) Mode Selection

The S100 Extension I/O supports both PNP (Source) and NPN (Sink) modes for sequence inputs at the terminal. Select an appropriate mode to suit requirements using the PNP/NPN selection switch (SW1) on the control board. Refer to the following information for detailed applications.

- NPN Mode (Sink)

Select NPN using the PNP/NPN selection switch (SW1). Note that the factory default setting is NPN mode. CM is the common ground terminal for all analog inputs at the terminal, and P12 is 12V internal source.

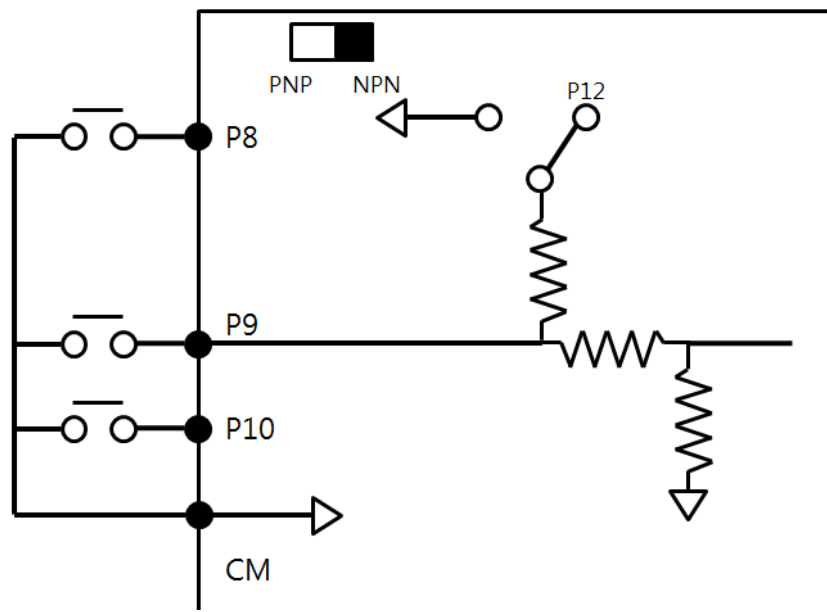

▪ PNP Mode (Source)

Select PNP using the PNP/NPN selection switch (SW1). Note that the factory default setting is NPN mode. CM is the common ground terminal for all analog inputs at the terminal, and P12 is 12V internal source. If you are using an external Voltage source, build a circuit that connects the external source (-) and the CM terminal. In case of PNP, you should apply more than 3V source for on-state and less than 2V for off-state.

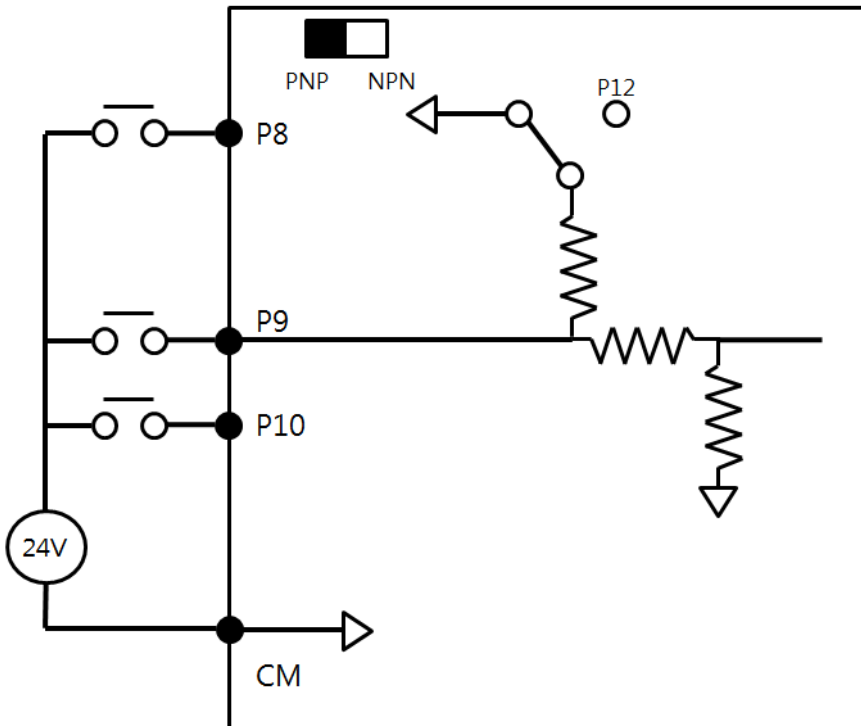

3.3 Signal (Control) Cable Specifications

Terminals	Signal Cable			
	Without Crimp Terminal Connectors (Bare Wire)		With Crimp Terminal Connectors (Bootlace Ferrule)	
	mm2	AWG	mm2	AWG
P8~P10/CM/V3/I4/AO3	0.75	18	0.5	20
A3/B3/C3 A4/B4/C4	1.0	17	1.5	15

• Preinsulated Crimp Terminal Connectors (Bootlace Ferrule) .

Use preinsulated crimp terminal connectors to increase reliability of the control terminal wiring. Refer to the specifications below to determine the crimp terminals to fit various cable sizes.

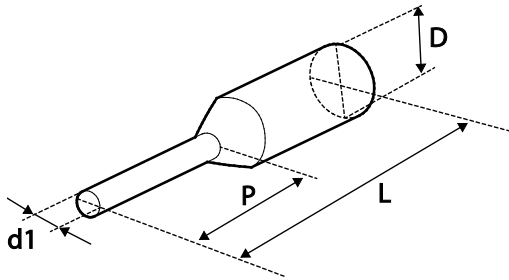

P/N	Cable Spec		Dimensions (inches/mm)				Manufacturer
	AWG	mm2	L*	P	d1	D	
CE002506	26	0.25	10.4	0.4 / 6.0	0.04 / 1.1	0.1 / 2.5	JEONO (Jeono Electric, http://www.jeono.com/)
CE002508			12.4	0.5 / 8.0			
CE005006	22	0.50	12.0	0.45 / 6.0	0.05 / 1.3	0.125 / 3.2	
CE007506	20	0.75	12.0	0.45 / 6.0	0.06 / 1.5	0.13 / 3.4	

* If the length (L) of the crimp terminals exceeds 0.5" (12.7mm) after wiring, the control terminal cover may not close fully.

To connect cables to the control terminals without using crimp terminals, refer to the following illustration detailing the correct length of exposed conductor at the end of the control cable.

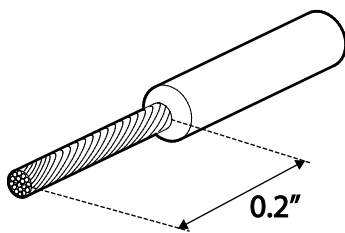

Note

While making wiring connections at the control terminals, ensure that the total cable length does not exceed 165ft (50m).

Ensure that the length of any safety related wiring does not exceed 100ft (30m).

Ensure that the cable length between an LCD keypad and the inverter does not exceed 10ft (3.04m). Cable connections longer than 10ft (3.04m) may cause signal errors.

Use ferrite material to protect signal cables from electro-magnetic interference.

Take care when supporting cables using cable ties, to apply the cable ties no closer than 6 inches from the inverter. This provides sufficient access to fully close the front cover.

When making control terminal cable connections, use a small flat-tip screw driver (0.1in wide (2.5mm) and 0.015in thick (0.4mm) at the tip).

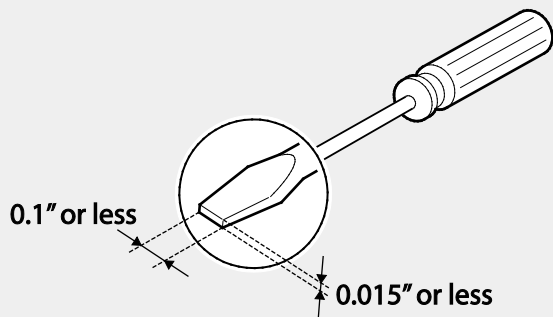

Chapter 4. Basic Features

4.1 Basic function

Basic Function	Example
Frequency reference source configuration for the terminal block (input voltage)	Configures the inverter to allow input voltages at the terminal block (V3, V4) and to setup or modify a frequency reference.
Frequency reference source configuration for the terminal block (input current)	Configures the inverter to allow input currents at the terminal block (I4) and to setup or modify a frequency reference.
Multi-step speed (frequency) configuration	Configures multi-step frequency operations by receiving an input at the terminals defined for each step frequency.
Multi-stage Acc/Dec time configuration using the multi-function terminal	Configures multi-stage acceleration and deceleration times for a motor based on defined parameters for the multi-function terminals.
Command source configuration for terminal block inputs	Configures the inverter to accept inputs at the FX/RX terminals.
Multi-function input terminal control configuration	Enables the user to improve the responsiveness of the multi-function input terminals.

4.2 Setting Frequency Reference

Group	Code	Name	LCD Display	Parameter Setting	Setting Range	Unit	
Operation	Frq	Frequency reference source	Ref Freq Src	0	KeyPad-1	0-16	-
				1	KeyPad-2		
				2	V1		
				4	V2		
				5	I2		
				6	Int 485		
				8	Field Bus		
				12	Pulse		
				13	V3		
				15	V4		
				16	I4		

4.2.1 V3 Terminal as the Source

You can set and modify a frequency reference by setting voltage inputs when using the V3 terminal. Use voltage inputs ranging from 0 to 10V (unipolar) for forward only operation. Use voltage inputs ranging from -10 to +10V (bipolar) for both directions, where negative voltage inputs are used reverse operations.

Setting a Frequency Reference for 0–10V Input

Set the Frq (Frequency reference source) code in the Operation group to 13 (V3), and then set code 02 (V3 Polarity) to 0 (unipolar) in the AO group. Use a voltage output from an external source or use the voltage output from the VR terminal(Standard I/O) to provide inputs to V3. Refer to the diagrams below for the wiring required for each application.

Group	Code	Name	LCD Display	Parameter Setting	Setting Range	Unit
Operation	Frq	Frequency reference source	Freq Ref Src	13 V3	0–16	-
In	01	Frequency at maximum analog input	Freq at 100%	Maximum frequency	0.00–Max. Frequency	Hz
Ao	01	V3 input monitor	V3 Monitor [V]	0.00	0.00–12.00	V
	02	V3 polarity options	V3 Polarity	0 Unipolar	0–1	-
	03	V3 input filter time constant	V3 Filter	10	0–10000	ms
	04	V3 minimum input voltage	V3 volt x1	0.00	0.00–10.00	V
	05	V3 output at minimum voltage (%)	V3 Perc y1	0.00	0.00–100.00	%
	06	V3 maximum input voltage	V3 Volt x2	10.00	0.00–12.00	V
	07	V3 output at maximum voltage (%)	V3 Perc y2	100.00	0–100	%
	08	Rotation direction options	V3 Inverting	0 No	0–1	-
	09	V3 Quantizing level	V3 Quantizing	0.04	0.00*, 0.04–10.00	%

* Quantizing is disabled if '0' is selected.

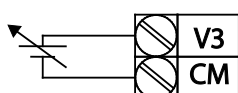

[External source application]

0-10V Input Voltage Setting Details

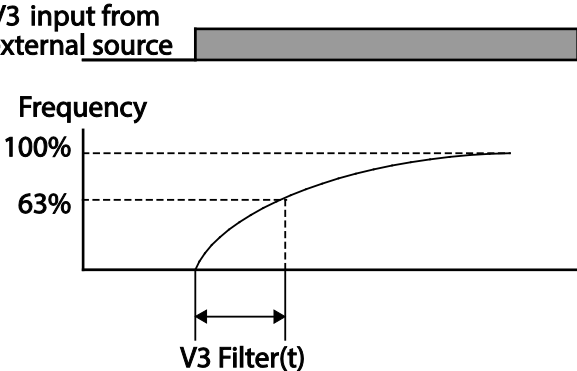
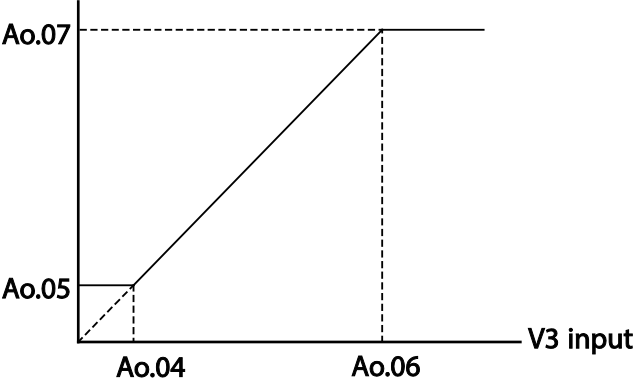
Code	Description
In.01 Freq at 100%	<p>Configures the frequency reference at the maximum input voltage when a potentiometer is connected to the control terminal block. A frequency set with code In.01 becomes the maximum frequency only if the value set in code Ao.07 (or Ao.13) is 100%.</p> <ul style="list-style-type: none"> Set code In.01 to 40.00 and use default values for codes Ao.01–Ao.09. Motor will run at 40.00Hz when a 10V input is provided at V3 Set code Ao.07 to 50.00 and use default values for codes In.01, Ao.01–Ao.09. Motor will run at 30.00Hz (50% of the default maximum frequency–60Hz) when a 10V input is provided at V3.
Ao.01 V3 Monitor[V]	<p>Configures the inverter to monitor the input voltage at V3.</p>
Ao.03 V3 Filter	<p>V3 Filter may be used when there are large variations between reference frequencies. Variations can be mitigated by increasing the time constant, but this will require an increased response time.</p> <p>The value t (time) indicates the time required for the frequency to reach 63% of the reference, when external input voltages are provided in multiple steps.</p> <div style="text-align: center;"> <p>V3 input from external source</p>  </div> <p>[V3 Filter]</p>
Ao.04 V3 Volt x1– Ao.07 V3 Perc y2	<p>These parameters are used to configure the gradient level and offset values of the Output Frequency, based on the Input Voltage.</p> <div style="text-align: center;"> <p>Frequency reference</p>  </div> <p>[Volt x1–Ao.07 V3 Perc y2]</p>

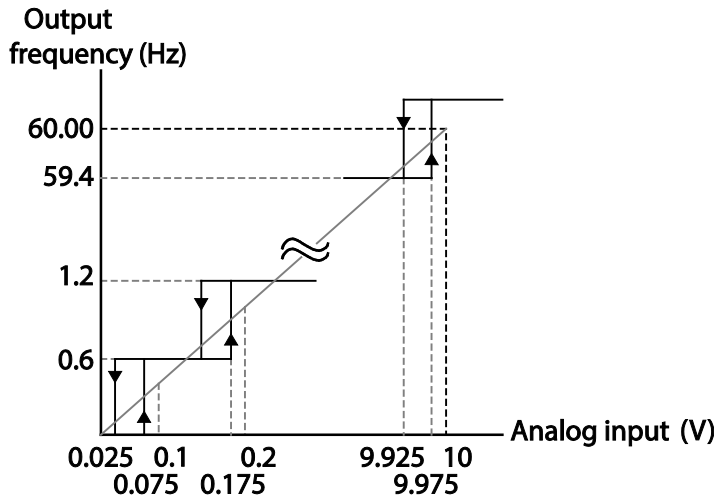
Code	Description
Ao.08 V3 Inverting	Inverts the direction of rotation. Set this code to 1 (Yes) if you need the motor to run in the opposite direction from the current rotation.
Ao.09.V3 Quantizing	<p>Quantizing may be used when the noise level is high in the analog input (V3 terminal) signal. Quantizing is useful when you are operating a noise-sensitive system, because it suppresses any signal noise. However, quantizing will diminish system sensitivity (resultant power of the output frequency will decrease based on the analog input).</p> <p>You can also turn on the low-pass filter using code Ao.03 to reduce the noise, but increasing the value will reduce responsiveness and may cause pulsations (ripples) in the output frequency.</p> <p>Parameter values for quantizing refer to a percentage based on the maximum input. Therefore, if the value is set to 1% of the analog maximum input (60Hz), the output frequency will increase or decrease by 0.6Hz per 0.1V difference.</p> <p>When the analog input is increased, an increase to the input equal to 75% of the set value will change the output frequency, and then the frequency will increase according to the set value. Likewise, when the analog input decreases, a decrease in the input equal to 75% of the set value will make an initial change to the output frequency.</p> <p>As a result, the output frequency will be different at acceleration and deceleration, mitigating the effect of analog input changes over the output frequency.</p> <p>Output frequency (Hz)</p>  <p>[V3 Quantizing]</p>

Setting a Frequency Reference for -10~10V Input

Set the Frq (Frequency reference source) code in the Operation group to 13 (V3), and then set code 02 (V3 Polarity) to 1 (bipolar) in the APO group (Ao). Use the output voltage from an external source to provide input to V3

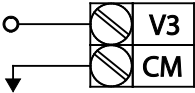

[V3 terminal wiring]

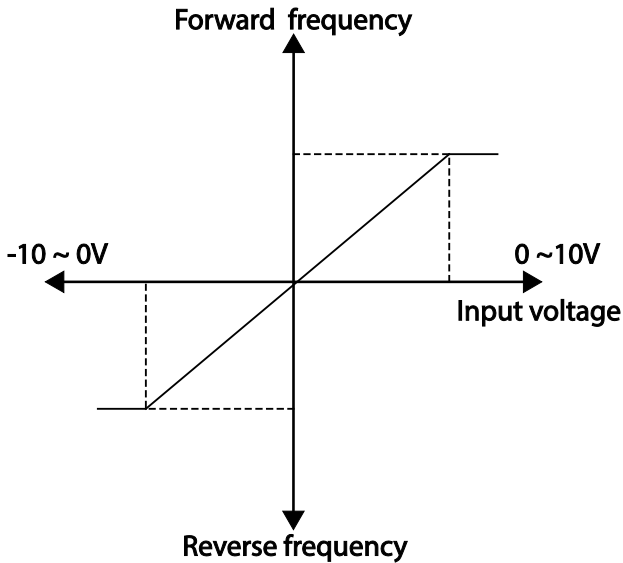

[Bipolar input voltage and output frequency]

Group	Code	Name	LCD Display	Parameter Setting	Setting Range	Unit
Operation	Frq	Frequency reference source	Freq Ref Src	13 V3	0-16	-
In	01	Frequency at maximum analog input	Freq at 100%	60.00	0- Max Frequency	Hz
Ao	01	V3 input monitor	V3 Monitor	0.00	0.00-12.00V	V
	02	V3 polarity options	V3 Polarity	1 Bipolar	0-1	-
	10	V3 minimum input voltage	V3- volt x1	0.00	10.00-0.00V	V
	11	V3 output at minimum voltage (%)	V3- Perc y1	0.00	-100.00-0.00%	%
	12	V3maximum input voltage	V3- Volt x2	-10.00	-12.00-0.00V	V
	13	V3 output at maximum voltage (%)	V3- Perc y2	-100.00	-100.00-0.00%	%

Rotational Directions for Different Voltage Inputs

Command / Voltage Input	Input voltage	
	0-10V	-10-0V
FWD	Forward	Reverse
REV	Reverse	Forward

-10-10V Voltage Input Setting Details

Code	Description
Ao.10 V3- volt x1- Ao.13 V1- Perc y2	<p>Sets the gradient level and off-set value of the output frequency in relation to the input voltage. These codes are displayed only when Ao.02 is set to 1 (bipolar). As an example, if the minimum input voltage (at V3) is set to -2 (V) with 10% output ratio, and the maximum voltage is set to -8 (V) with 80% output ratio respectively, the output frequency will vary within the range of 6 - 48 Hz.</p> <p>[Ao.10 V3-volt X1-Ao.13 V3 Perc y]</p> <p>For details about the 0-+10V analog inputs, refer to the code descriptions Ao.10 V3 volt x1-Ao.13 V1 Perc y2..</p>

Setting a Reference Frequency using Input Current (I4)

You can set and modify a frequency reference using input current at the I4 terminal after selecting current input at SW 2. Set the Frq (Frequency reference source) code in the Operation group to 16 (I4) and apply 4-20mA input current to I4.

Group	Code	Name	LCD Display	Parameter Setting	Setting Range	Unit
Operation	Frq	Frequency reference source	Freq Ref Src	16 I4	0-16	-
In	01	Frequency at maximum analog input	Freq at 100%	60.00	0- Maximum Frequency	Hz
Ao	22	I4 input monitor	I4 Monitor	0.00	0.00-24.00	mA
	23	I4 input filter time constant	I4 Filter	10	0-10000	ms
	24	I4 minimum input current	I4 Curr x1	4.00	0.00-20.00	mA

Group	Code	Name	LCD Display	Parameter Setting	Setting Range	Unit	
	25	I4 output at minimum current (%)	I4 Perc y1	0.00	0-100	%	
	26	I4 maximum input current	I4 Curr x2	20.00	0.00-24.00	mA	
	27	I4 output at maximum current (%)	I4 Perc y2	100.00	0.00-100.00	%	
	28	I4 rotation direction options	I4 Inverting	0	No	0-1	-
	29	I4 Quantizing level	I4 Quantizing	0.04	0*	0.04-10.00	%

* Quantizing is disabled if '0' is selected.

Input Current (I4) Setting Details

Code	Description
In.01 Freq at 100%	<p>Configures the frequency reference for operation at the maximum current (when Ao.27 is set to 100%).</p> <ul style="list-style-type: none"> If In.01 is set to 40.00Hz, and default settings are used for Ao.24-27, 20mA input current (max) to I4 will produce a frequency reference of 40.00Hz. If Ao.27 is set to 50.00 (%), and default settings are used for In.01 (60Hz) and Ao.24-26, 20mA input current (max) to I4 will produce a frequency reference of 30.00Hz (50% of 60Hz).
Ao.22 I4 Monitor	Used to monitor input current at I4.
Ao.23 I4 Filter	Configures the time for the operation frequency to reach 63% of target frequency based on the input current at I4.
In.24 I4 Curr x1- In.27 I4 Perc y2	<p>Configures the gradient level and off-set value of the output frequency.</p> <p>Frequency Reference</p> <p>[Gradient and off-set configuration based on output frequency]</p>

4.2.2 Setting a Frequency Reference with Input Voltage (Terminal I4)

Set and modify a frequency reference using input voltage at I4 (V4) terminal by setting SW2 to V4. Set the Frq (Frequency reference source) code in the Operation group to 15 (V4) and apply 0-12V input voltage to I4 (=V4, Analog current/voltage input terminal). Codes Ao.14-21 will not be displayed when I4 is set to receive current input (Frq code parameter is set to 16).

Group	Code	Name	LCD Display	Parameter Setting		Setting Range	Unit
Operation	Frq	Frequency reference source	Freq Ref Src	15	V4	0-16	-
Ao	14	V4 input display	V4 Monitor	0.00		0.00-12.00	V
	15	V4 input filter time constant	V4 Filter	10		0-10000	ms
	16	Minimum V4 input voltage	V4 Volt x1	0.00		0.00-10.00	V
	17	Output% at minimum V4 voltage	V4 Perc y1	0.00		0.00-100.00	%
	18	Maximum V4 input voltage	V4 Volt x2	10.00		0.00-10.00	V
	19	Output% at maximum V4 voltage	V4 Perc y2	100.00		0.00-100.00	%
	20	Invert V4 rotational direction	V4 Inverting	0	No	0-1	-
	21	V4 quantizing level	V4 Quantizing	0.04		0.00*, 0.04-10.00	%

* Quantizing is disabled if '0' is selected.

4.3 Analog Output

An analog output terminal provides output of 0-10V voltage, 4-20mA current.

Voltage and Current Analog Output

An output size can be adjusted by selecting an output option at AO3(Analog Output3) terminal. Set the analog voltage/current output terminal setting switch (SW3) to change the output type (voltage/current).

Group	Code	Name	LCD Display	Parameter Setting		Setting Range	Unit
Ao	30	Analog output3	AO3 Mode	0	Frequency	0-15	-
	31	Analog output3 gain	AO3 Gain	100.0		-1000.0-1000.0	%
	32	Analog output3 bias	AO3 Bias	0.0		-100.0-100.0	%
	33	Analog output3 filter	AO3 Filter	5		0-10000	ms
	34	Analog constant output3	AO3 Const %	0.0		0.0-100.0	%
	35	Analog output3 monitor	AO3 Monitor	0.0		0.0-1000.0	%

Voltage and Current Analog Output Setting Details

Code	Description																														
AO.30 AO3 Mode	Select a constant value for output. The following example for output voltage setting.																														
	<table border="1"> <thead> <tr> <th>Setting</th> <th>Function</th> </tr> </thead> <tbody> <tr> <td>0</td> <td>Frequency</td> </tr> <tr> <td>1</td> <td>Output Current</td> </tr> <tr> <td>2</td> <td>Output Voltage</td> </tr> <tr> <td>3</td> <td>DC Link Volt</td> </tr> <tr> <td>4</td> <td>Torque</td> </tr> <tr> <td>5</td> <td>Ouput Power</td> </tr> <tr> <td>6</td> <td>ldse</td> </tr> <tr> <td>7</td> <td>lqse</td> </tr> <tr> <td>8</td> <td>Target Freq</td> </tr> <tr> <td>9</td> <td>Ramp Freq</td> </tr> <tr> <td>12</td> <td>PID Ref Value</td> </tr> <tr> <td>13</td> <td>PID Fdk Value</td> </tr> <tr> <td>14</td> <td>PID Output</td> </tr> <tr> <td>15</td> <td>Constant</td> </tr> </tbody> </table>	Setting	Function	0	Frequency	1	Output Current	2	Output Voltage	3	DC Link Volt	4	Torque	5	Ouput Power	6	ldse	7	lqse	8	Target Freq	9	Ramp Freq	12	PID Ref Value	13	PID Fdk Value	14	PID Output	15	Constant
	Setting	Function																													
	0	Frequency																													
	1	Output Current																													
	2	Output Voltage																													
	3	DC Link Volt																													
	4	Torque																													
	5	Ouput Power																													
	6	ldse																													
	7	lqse																													
	8	Target Freq																													
	9	Ramp Freq																													
	12	PID Ref Value																													
	13	PID Fdk Value																													
14	PID Output																														
15	Constant																														
AO.31 AO3 Gain, AO.32 AO3 Bias	Adjusts output value and offset. If frequency is selected as an output item, it will operate as shown below.																														
	$AO3 = \frac{Frequency}{MaxFreq} \times AO3\ Gain + AO3\ Bias$ <p>The graph below illustrates the analog voltage output (AO3) changes depend on Ao.31 (AO3 Gain) and Ao.32 (AO3 Bias) values. Y-axis is analog output voltage (0-10V), and X-axis is % value of the output item.</p>																														

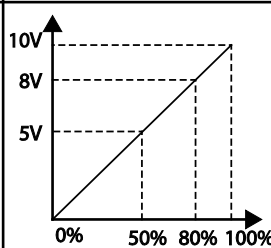
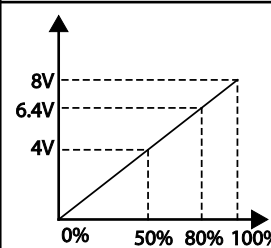
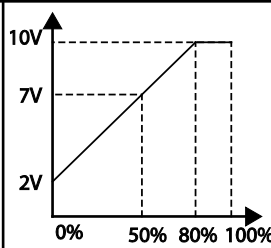
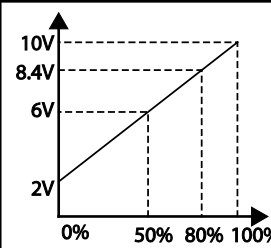
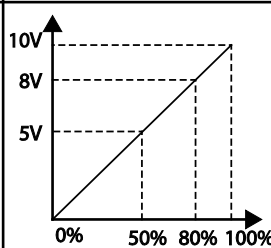
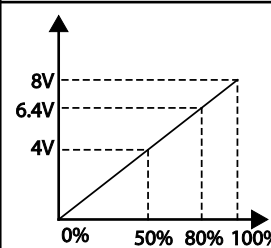
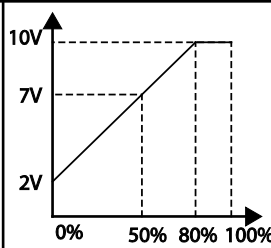
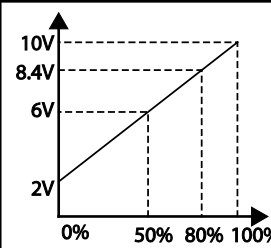
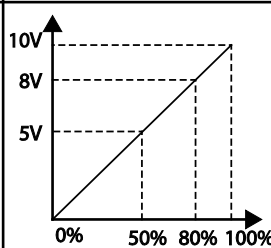
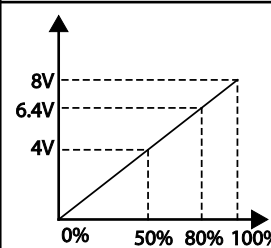
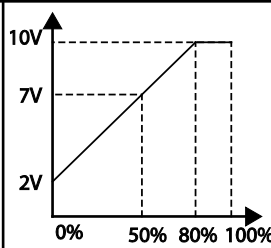
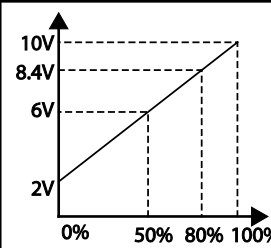
Code	Description															
	<p>Example, if the maximum frequency set at dr.20 (Max Freq) is 60Hz and the present output frequency is 30Hz, then the x-axis value on the next graph is 50%.</p> <div style="text-align: center;"> <table border="1" style="margin: auto;"> <thead> <tr> <th colspan="2"></th> <th colspan="2">Ao.31 AO3 Gain</th> </tr> <tr> <th colspan="2"></th> <th>100.0% (Factory default)</th> <th>80.0%</th> </tr> </thead> <tbody> <tr> <td rowspan="2" style="vertical-align: middle;">Ao.32 AO3 Bias</td> <td style="text-align: center;">0.0% Factory default</td> <td></td> <td></td> </tr> <tr> <td style="text-align: center;">20.0%</td> <td></td> <td></td> </tr> </tbody> </table> </div>			Ao.31 AO3 Gain				100.0% (Factory default)	80.0%	Ao.32 AO3 Bias	0.0% Factory default			20.0%		
		Ao.31 AO3 Gain														
		100.0% (Factory default)	80.0%													
Ao.32 AO3 Bias	0.0% Factory default															
	20.0%															
AO.33 AO3 Filter	Set filter time constant on analog output.															
AO.34 A013Const %	If analog output at AO.30 (AO3 Mode) is set to 15(Constant), the analog voltage output is dependent on the set parameter values (0-100%).															
AO.35 AO3 Monitor	Monitors analog output value. Displays the maximum output voltage as a percentage (%) with 10V as the standard.															

4.4 Digital Output

4.4.1 Multi-function Output Terminal and Relay Settings

Group	Code	Name	LCD Display	Parameter Setting	Setting Range	Unit
OU	30	Fault output item	Trip Out Mode	010*	-	bit
	34	Multi-function relay3 setting	Relay 3	29 Trip	-	-
	35	Multi-function relay4 setting	Relay 4	29 Trip	-	-
	41	Multi-function output monitor	DO Status	-	00- 11	bit
	57	Detection frequency	FDT Frequency	30.00	0.00-Maximum frequency	Hz
	58	Detection frequency band	FDT Band	10.00		
In	65-74	Px terminal configuration	Px Define	16 Exchange	-	-

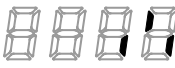
*Displayed as  on the keypad.

Multi-function Output Terminal and Relay Setting Details

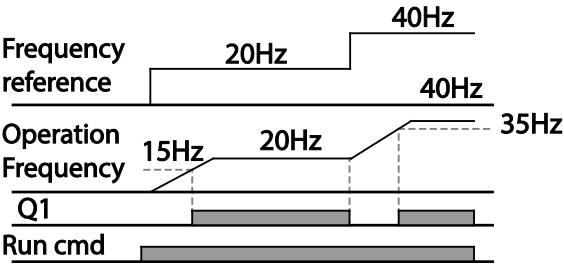
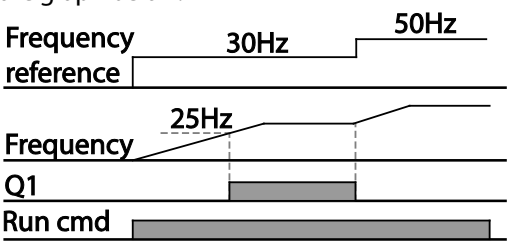
Code	Description		
OU.34 Relay3	Set relay (Relay 3) output options.		
OU.35 Relay4	Set relay (Relay 4) output options.		
OU.41 DO Status	Set output terminal and relay functions according to OU.57 FDT (Frequency), OU.58 (FDT Band) settings and fault trip conditions.		
	Setting	Function	
	0	None	No output signal.
	1	FDT-1	<p>Detects inverter output frequency reaching the user set frequency. Outputs a signal when the absolute value (set frequency-output frequency) < detected frequency width/2.</p> <p>When detected frequency width is 10Hz, FDT-1 output is as shown in the graph below.</p> 
2	FDT-2	<p>Outputs a signal when the user set frequency and detected frequency (FDT Frequency) are equal, and fulfills FDT-1 condition at the same time.</p> <p>[Absolute value (set frequency-detected frequency) < detected frequency width/2]&[FDT-1]</p> <p>Detected frequency width is 10Hz. When the detected frequency is set to 30Hz, FDT-2 output is as shown in the graph below.</p> 	
3	FDT-3	<p>Outputs a signal when the Absolute value (output frequency-operation frequency) < detected frequency width/2.</p> <p>Detected frequency width is 10Hz. When detected frequency is set to 30Hz, FDT-3 output is as shown in</p>	

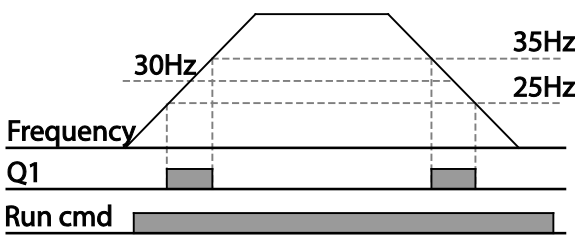
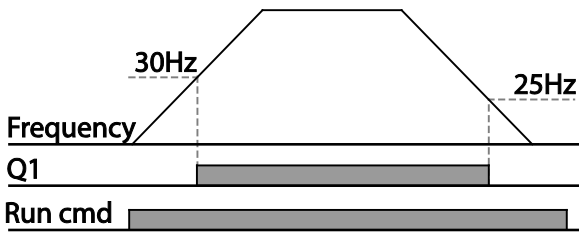
Code	Description	
		<p>the graph below.</p> 
4	FDT-4	<p>Output signal can be separately set for acceleration and deceleration conditions.</p> <ul style="list-style-type: none"> • In acceleration: Operation frequency \geq Detected frequency • In deceleration: Operation frequency $>$ (Detected frequency - Detected frequency width / 2) <p>Detected frequency width is 10Hz. When detected frequency is set to 30Hz, FDT-4 output is as shown in the graph below.</p> 
5	Overload	Outputs a signal at motor overload.
6	IOL	Outputs a signal when a fault is triggered from a protective function operation by inverter overload inverse proportion.
7	Underload	Outputs a signal at load fault warning.
8	Fan Warning	Outputs a signal at fan fault warning.
9	Stall	Outputs a signal when a motor is overloaded and stalled.
10	Over voltage	Outputs a signal when the inverter DC link voltage rises above the protective operation voltage.
11	Low Voltage	Outputs a signal when the inverter DC link voltage drops below the low voltage protective level.
12	Over Heat	Outputs signal when the inverter overheats.
13	Lost command	<p>Outputs a signal when there is a loss of analog input terminal and RS-485 communication command at the terminal block.</p> <p>Outputs a signal when communication power and expansion an I/O power card is installed, and also outputs a signal when losing analog input and communication power commands.</p>
14	RUN	<p>Outputs a signal when operation command is entered and the inverter outputs voltage.</p> <p>No signal output during DC braking.</p>

Code	Description	
		<p>The diagram shows three signals over time. The top signal is 'Frequency', which is a trapezoidal wave that rises, stays at a constant level, and then falls. The middle signal is 'Q1', which is a pulse that starts at the beginning of the frequency rise and ends at the beginning of the frequency fall. The bottom signal is 'Run cmd', which is a pulse that starts at the beginning of the frequency rise and ends at the end of the frequency rise.</p>
15	Stop	Outputs a signal at operation command off, and when there is no inverter output voltage.
16	Steady	Outputs a signal in steady operation.
17	Inverter line	Outputs a signal while the motor is driven by the inverter line.
18	Comm line	Outputs a signal while the motor is driven by a commercial power source..
19	Speed search	Outputs a signal during inverter speed search operation.
22	Ready	Outputs signal when the inverter is in stand by operation and ready to receive an external operation command.
28	Timer Out	A timer function to operate terminal output after a certain time by using multi-function terminal block input..
29	Trip	Outputs a signal after a fault trip
31	DB Warn %ED	In case of exceeding DB resistor usage rate, the signal changes to on-state.
34	On/Off Control	Outputs a signal using an analog input value as a standard.
35	BR Control	Outputs a brake release signal.

4.4.2 Fault Trip Output using Multi-Function Output Terminal and Relay

The inverter can output fault trip state using multi-function output terminal (Q1) and relay (Relay 3, 4).

Group	Code	Name	LCD Display	Parameter Setting		Setting Range	Unit
OU	30	Fault trip output mode	Trip Out Mode	010		-	bit
	34	Multi-function relay3 setting	Relay 3	29	Trip	-	-
	35	Multi-function relay4 setting	Relay 4	29	Trip	-	-
	53	Fault trip output on delay	TripOut OnDly	0.00		0.00–100.00	sec
	54	Fault trip output off delay	TripOut OffDly	0.00		0.00–100.00	sec

Fault Trip Output by Multi-function Output Terminal and Relay - Setting Details

Code	Description																		
OU.30 Trip Out Mode	Fault trip relay operates based on the fault trip output settings.																		
	<table border="1"> <thead> <tr> <th>Item</th> <th>bit on</th> <th>bit off</th> </tr> </thead> <tbody> <tr> <td>Keypad</td> <td></td> <td></td> </tr> <tr> <td>LCD keypad</td> <td></td> <td></td> </tr> </tbody> </table>	Item	bit on	bit off	Keypad			LCD keypad											
	Item	bit on	bit off																
	Keypad																		
	LCD keypad																		
Select fault trip output terminal/relay and select 29(Trip Mode) at codes OU.34, 35. When a fault trip occurs in the inverter, the relevant terminal and relay will operate. Depending on the fault trip type, terminal and relay operation can be configured as shown in the table below.																			
<table border="1"> <thead> <tr> <th colspan="3">Setting</th> <th rowspan="2">Function</th> </tr> <tr> <th>bit3</th> <th>bit2</th> <th>bit1</th> </tr> </thead> <tbody> <tr> <td></td> <td></td> <td>✓</td> <td>Operates when low voltage fault trips occur</td> </tr> <tr> <td></td> <td>✓</td> <td></td> <td>Operates when fault trips other than low voltage occur</td> </tr> <tr> <td>✓</td> <td></td> <td></td> <td>Operates when auto restart fails (Pr. 08-09)</td> </tr> </tbody> </table>	Setting			Function	bit3	bit2	bit1			✓	Operates when low voltage fault trips occur		✓		Operates when fault trips other than low voltage occur	✓			Operates when auto restart fails (Pr. 08-09)
Setting			Function																
bit3	bit2	bit1																	
		✓	Operates when low voltage fault trips occur																
	✓		Operates when fault trips other than low voltage occur																
✓			Operates when auto restart fails (Pr. 08-09)																
OU.34 Relay3	Set relay output (Relay 3).																		
OU.35 Relay4	Set relay output (Relay 4).																		
OU.53 TripOut On Dly, OU.54 TripOut OffDly	If a fault trip occurs, trip relay or multi-function output operates after the time delay set in OU.53. Terminal is off with the input initialized after the time delay set in OU.54.																		

4.4.3 Multi-function Output Terminal Delay Time Settings





Set on-delay and off-delay times separately to control the output terminal and relay operation times. The delay time set at codes OU.50-51 applies to multi-function output terminal (Q1), relay (Relay 1, 3, 4), except when the multi-function output function is in fault trip mode.

Group	Code	Name	LCD Display	Parameter Setting	Setting Range	Unit
OU	50	Multi-function output On delay	DO On Delay	0.00	0.00-100.00	s
	51	Multi-function output Off delay	DO Off Delay	0.00	0.00-100.00	s
	52	Select multi-function output terminal	DO NC/NO Sel	00*	00-11	bit

* Displayed as on keypad. On the 7-seg screen of multi-function output contact parameter, clicking of left/right key switches between extension I/O and built-in I/O 7-seg screen.

is extension I/O 7-seg screen.

Output Terminal Delay Time Setting Details

Code	Description		
OU.52 DO NC/NO Sel	Select terminal type for relay and multi-function output terminal. An additional three terminal type selection bits at the terminal block will be added when an expansion I/O is added. By setting the relevant bit to 0, it will operate A terminal (Normally Open), and setting it to 1 will operate B terminal (Normally Closed). Shown below in the table are Relay 1 and Q1 settings starting from the right bit.		
	Item	bit on	bit off
	Keypad		
	LCD keypad		

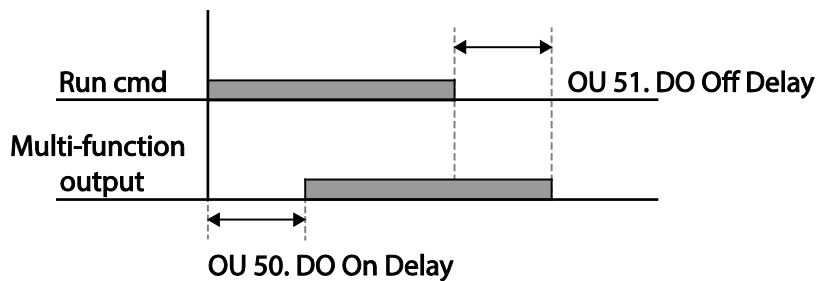

4.5 Setting Multi-step Frequency

Multi-step operations can be carried out by assigning different speeds (or frequencies) to the Px terminals. Step 0 uses the frequency reference source set with the Frq code in the Operation group. Px terminal parameter values 7 (Speed-L), 8 (Speed-M) and 9 (Speed-H) are recognized as binary commands and work in combination with Fx or Rx run commands. The inverter operates according to the frequencies set with St.1–3 (multi-step frequency 1–3), bA.53–56 (multi-step frequency 4–7) and the binary command combinations.

Group	Code	Name	LCD Display	Parameter Setting		Setting Range	Unit
Operation	St1–St3	Multi-step frequency 1–3	Step Freq - 1–3	-		0-Maximum frequency	Hz
bA	53–56	Multi-step frequency 4–7	Step Freq - 4–7	-		0-Maximum frequency	Hz
In	72–74	Px terminal configuration	Px Define (Px: P8–P10)	7	Speed-L	0–54	-
				8	Speed-M		-
9				Speed-H	-		
	89	Multi-step command delay time	InCheckTime	1		1–5000	ms

Multi-step Frequency Setting Details

Code	Description																																													
Operation group St 1-St3 Step Freq - 1-3	Configure multi-step frequency1-3. If an LCD keypad is in use, bA.50-52 is used instead of St1-St3 (multi-step frequency 1-3).																																													
bA.53-56 Step Freq - 4-7	Configure multi-step frequency 4-7.																																													
In.72-74 Px Define	<p>Choose the terminals to setup as multi-step inputs, and then set the relevant codes (In.72-74) to 7(Speed-L), 8(Speed-M), or 9(Speed-H).</p> <p>Provided that terminals P3, P4 and P5 have been set to Speed-L, Speed-M and Speed-H respectively, the following multi-step operation will be available.</p> <p>[An example of a multi-step operation]</p> <table border="1"> <thead> <tr> <th>Speed</th> <th>Fx/Rx</th> <th>P5</th> <th>P4</th> <th>P3</th> </tr> </thead> <tbody> <tr> <td>0</td> <td>✓</td> <td>-</td> <td>-</td> <td>-</td> </tr> <tr> <td>1</td> <td>✓</td> <td>-</td> <td>-</td> <td>✓</td> </tr> <tr> <td>2</td> <td>✓</td> <td>-</td> <td>✓</td> <td>-</td> </tr> <tr> <td>3</td> <td>✓</td> <td>-</td> <td>✓</td> <td>✓</td> </tr> <tr> <td>4</td> <td>✓</td> <td>✓</td> <td>-</td> <td>-</td> </tr> <tr> <td>5</td> <td>✓</td> <td>✓</td> <td>-</td> <td>✓</td> </tr> <tr> <td>6</td> <td>✓</td> <td>✓</td> <td>✓</td> <td>-</td> </tr> <tr> <td>7</td> <td>✓</td> <td>✓</td> <td>✓</td> <td>✓</td> </tr> </tbody> </table>	Speed	Fx/Rx	P5	P4	P3	0	✓	-	-	-	1	✓	-	-	✓	2	✓	-	✓	-	3	✓	-	✓	✓	4	✓	✓	-	-	5	✓	✓	-	✓	6	✓	✓	✓	-	7	✓	✓	✓	✓
Speed	Fx/Rx	P5	P4	P3																																										
0	✓	-	-	-																																										
1	✓	-	-	✓																																										
2	✓	-	✓	-																																										
3	✓	-	✓	✓																																										
4	✓	✓	-	-																																										
5	✓	✓	-	✓																																										
6	✓	✓	✓	-																																										
7	✓	✓	✓	✓																																										
In.89 InCheckTime	<p>Set a time interval for the inverter to check for additional terminal block inputs after receiving an input signal.</p> <p>After adjusting In.89 to 100ms and an input signal is received at P8, the inverter will search for inputs at other terminals for 100ms, before proceeding to accelerate or decelerate based on P8's configuration.</p>																																													

4.6 Multi-step Acc/Dec Time Configuration

Acc/Dec times can be configured via a multi-function terminal by setting the ACC (acceleration time) and dEC (deceleration time) codes in the Operation group.

Group	Code	Name	LCD Display	Parameter Setting	Setting Range	Unit	
Operation	ACC	Acceleration time	Acc Time	20.0	0.0–600.0	sec	
	dEC	Deceleration time	Dec Time	30.0	0.0–600.0	sec	
bA	70-82	Multi-step acceleration time1-7	Acc Time 1-7	x.xx	0.0–600.0	sec	
	71-83	Multi-step deceleration time1-7	Dec Time 1-7	x.xx	0.0–600.0	sec	
In	72-74	Px terminal configuration	Px Define (Px: P8–P10)	11	XCEL-L	0–54	-
				12	XCEL-M		
49				XCEL-H			
	89	Multi-step command delay time	In Check Time	1	1–5000	ms	

Acc/Dec Time Setup via Multi-function Terminals – Setting Details

Code	Description												
bA.70–82 Acc Time 1–7	Set multi-step acceleration time1-7.												
bA.71–83 Dec Time 1–7	Set multi-step deceleration time1-7.												
In.72–74 Px Define (P1–P7)	Choose and configure the terminals to use for multi-step Acc/Dec time inputs.												
	<table border="1"> <thead> <tr> <th colspan="2">Configuration</th> <th>Description</th> </tr> </thead> <tbody> <tr> <td>11</td> <td>XCEL-L</td> <td>Acc/Dec command-L</td> </tr> <tr> <td>12</td> <td>XCEL-M</td> <td>Acc/Dec command-M</td> </tr> <tr> <td>49</td> <td>XCEL-H</td> <td>Acc/Dec command-H</td> </tr> </tbody> </table>	Configuration		Description	11	XCEL-L	Acc/Dec command-L	12	XCEL-M	Acc/Dec command-M	49	XCEL-H	Acc/Dec command-H
	Configuration		Description										
	11	XCEL-L	Acc/Dec command-L										
	12	XCEL-M	Acc/Dec command-M										
49	XCEL-H	Acc/Dec command-H											
Acc/Dec commands are recognized as binary code inputs and will control the acceleration and deceleration based on parameter values set with bA.70-82 and bA.71-83.													
If, for example, the P8 and P9 terminals are set as XCEL-L and XCEL respectively, the following operation will be available.													

Code	Description															
	<table border="1"> <thead> <tr> <th>Acc/Dec time</th> <th>P5</th> <th>P4</th> </tr> </thead> <tbody> <tr> <td>0</td> <td>-</td> <td>-</td> </tr> <tr> <td>1</td> <td>-</td> <td>✓</td> </tr> <tr> <td>2</td> <td>✓</td> <td>-</td> </tr> <tr> <td>3</td> <td>✓</td> <td>✓</td> </tr> </tbody> </table>	Acc/Dec time	P5	P4	0	-	-	1	-	✓	2	✓	-	3	✓	✓
Acc/Dec time	P5	P4														
0	-	-														
1	-	✓														
2	✓	-														
3	✓	✓														
In.89 In Check Time	Set the time for the inverter to check for other terminal block inputs. If In.89 is set to 100ms and a signal is supplied to the P8 terminal, the inverter searches for other inputs over the next 100ms. When the time expires, the Acc/Dec time will be set based on the input received at P8.															

4.7 Stopping the Acc/Dec Operation

Configure the multi-function input terminals to stop acceleration or deceleration and operate the inverter at a fixed frequency.

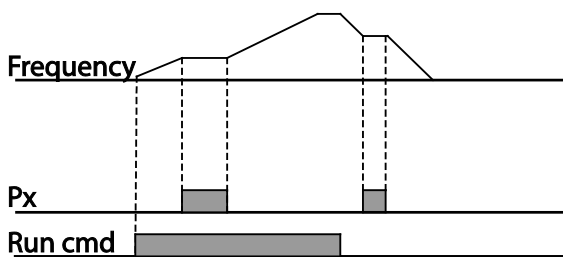

Group	Code	Name	LCD Display	Parameter Setting	Setting Range	Unit
In	65-71	Px terminal configuration	Px Define(Px: P1-P7)	25 XCEL Stop	0-54	-







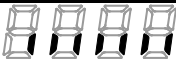



















4.8 Multi-function Input Terminal Control

Filter time constants and the type of multi-function input terminals can be configured to improve the response of input terminals

Group	Code	Name	LCD Display	Parameter Setting	Setting Range	Unit
In	85	Multi-function input terminal On filter	DI On Delay	10	0-10000	ms
	86	Multi-function input terminal Off filter	DI Off Delay	3	0-10000	ms
	87	Multi-function input terminal selection	DI NC/NO Sel	0 0000*	-	-
	90	Multi-function input terminal status	DI Status	0 0000*	-	-

* Displayed as  on the keypad. On the 7-seg screen of multi-function input state/contact parameter, clicking of left/right key switches between extension I/O and built-in I/O 7-seg screen.  is extension I/O 7-seg screen.

Multi-function Input Terminal Control Setting Details

Code	Description									
In.85 DI On Delay, In.86 DI Off Delay	If the input terminal's state is not changed during the set time, when the terminal receives an input, it is recognized as On or Off.									
In.87 DI NC/NO Sel	Select terminal contact types for each input terminal. The position of the indicator light corresponds to the segment that is on as shown in the table below. With the bottom segment on, it indicates that the terminal is configured as a A terminal (Normally Open) contact. With the top segment on, it indicates that the terminal is configured as a B terminal (Normally Closed) contact. From right to left side, there are P1~P7 terminals. In case of installation of extension I/O, P8/P9/P10 terminals are added. <table border="1" data-bbox="400 1424 1294 1630"> <thead> <tr> <th>Type</th> <th>B terminal status (Normally Closed)</th> <th>A terminal status (Normally Open)</th> </tr> </thead> <tbody> <tr> <td>Keypad</td> <td></td> <td></td> </tr> <tr> <td>LCD keypad</td> <td></td> <td></td> </tr> </tbody> </table>	Type	B terminal status (Normally Closed)	A terminal status (Normally Open)	Keypad			LCD keypad		
Type	B terminal status (Normally Closed)	A terminal status (Normally Open)								
Keypad										
LCD keypad										
In.90 DI Status	Display the configuration of each contact. When a segment is configured as A terminal using dr.87, the On condition is indicated by the top segment turning on. The Off condition is indicated when the bottom segment is turned on. When contacts are configured as B terminals, the segment lights behave conversely. From right to left side, there are P1~P7 terminals. In case of installation of extension I/O, P8/P9/P10 terminals are added. <table border="1" data-bbox="400 1865 1294 2033"> <thead> <tr> <th>Type</th> <th>A terminal setting (On)</th> <th>A terminal setting (Off)</th> </tr> </thead> <tbody> <tr> <td>Keypad</td> <td></td> <td></td> </tr> <tr> <td>LCD keypad</td> <td></td> <td></td> </tr> </tbody> </table>	Type	A terminal setting (On)	A terminal setting (Off)	Keypad			LCD keypad		
Type	A terminal setting (On)	A terminal setting (Off)								
Keypad										
LCD keypad										

Chapter 5. Table of Functions

This chapter lists all the function settings for S100 series inverter. Set the parameters required according to the following references. If a set value input is out of range, the following messages will be displayed on the keyboard. In these cases, the inverter will not operate with the [ENT] key.

- Set value not allocated: **rd**
- Set value repetition (multi-function input, PID reference, PID feedback related): **OL**
- Set value not allowed (select value, V2, I2): **no**

5.1 Operation Group

The Operation group is used only in the basic keypad mode. It will not be displayed on an LCD keypad. If the LCD keypad is connected, the corresponding functions will be found in the Drive(DRV) group.

SL: Sensorless vector control (dr.09)

***O/X:** Write-enabled during operation, **7/L/A:** Keypad/LCD keypad/Common

Code	Comm. Address	Name	Keypad Display	Setting Range	Initial Value	Property [#]	V/F	SL	Ref.																
	0h1F00	Target frequency	0.00	0-Maximum frequency(Hz)	0.00	O/7	O	O																	
-	0h1F01	Acceleration time	ACC	0.0-600.0(s)	20.0	O/7	O	O																	
-	0h1F02	Deceleration time	dEC	0.0-600.0(s)	30.0	O/7	O	O																	
-	0h1F03	Command source	drv	<table border="1"> <tr><td>0</td><td>Keypad</td></tr> <tr><td>1</td><td>Fx/Rx-1</td></tr> <tr><td>2</td><td>Fx/Rx-2</td></tr> <tr><td>3</td><td>Int 485</td></tr> <tr><td>4</td><td>Field Bus¹</td></tr> </table>	0	Keypad	1	Fx/Rx-1	2	Fx/Rx-2	3	Int 485	4	Field Bus ¹	1: Fx/Rx-1	X/7	O	O							
0	Keypad																								
1	Fx/Rx-1																								
2	Fx/Rx-2																								
3	Int 485																								
4	Field Bus ¹																								
-	0h1F04	Frequency reference source	Frq	<table border="1"> <tr><td>0</td><td>Keypad-1</td></tr> <tr><td>1</td><td>Keypad-2</td></tr> <tr><td>2</td><td>V1</td></tr> <tr><td>4</td><td>V2</td></tr> <tr><td>5</td><td>I2</td></tr> <tr><td>6</td><td>Int 485</td></tr> <tr><td>8</td><td>Field Bus</td></tr> <tr><td>12</td><td>Pulse</td></tr> </table>	0	Keypad-1	1	Keypad-2	2	V1	4	V2	5	I2	6	Int 485	8	Field Bus	12	Pulse	0: Keypad-1	X/7	O	O	
0	Keypad-1																								
1	Keypad-2																								
2	V1																								
4	V2																								
5	I2																								
6	Int 485																								
8	Field Bus																								
12	Pulse																								
-	0h1F05	Multi-step speed frequency 1	St1	0.00-Maximum frequency(Hz)	10.00	O/7	O	O																	
-	0h1F06	Multi-step speed frequency 2	St2	0.00-Maximum frequency(Hz)	20.00	O/7	O	O																	
-	0h1F07	Multi-step speed frequency 3	St3	0.00-Maximum frequency(Hz)	30.00	O/7	O	O																	
-	0h1F08	Output current	CUr			-/7	O	O																	
-	0h1F09	Motor revolutions per	Rpm			-/7	O	O																	

¹ Table of options are provided separately in the option manual.

Code	Comm. Address	Name	Keypad Display	Setting Range	Initial Value	Property*	V/F	SL	Ref.
-	0h1F0A	Inverter direct current voltage	dCL	-	-	-/7	O	O	
-	0h1F0B	Inverter output voltage	vOL			-/7	O	O	
-	0h1F0C	Out of order signal	nOn			-/7	O	O	
-	0h1F0D	Select rotation direction	drC	F Forward run r Reverse run	F	O/7	O	O	

5.2 Drive group (PAR→dr)

In the following table, data shaded in grey will be displayed when the related code has been selected.

SL: Sensorless vector control (dr.09)

***O/X:** Write-enabled during operation, **7/L/A:** Keypad/LCD keypad/Common

Code	Comm. Address	Name	LCD Display	Setting Range	Initial value	Property*	V/F	SL	Ref.
00	-	Jump Code	Jump Code	1-99	9	O/A	O	O	
01 ²	0h1101	Target frequency	Cmd Frequency	Start frequency - Maximum frequency(Hz)	0.00	O/L	O	O	
02	0h1102	Torque command	Cmd Torque	-180~180[%]	0.0	O/A	X	O	
03 ²	0h1103	Acceleration time	Acc Time	0.0-600.0(s)	20.0	O/L	O	O	
04 ²	0h1104	Deceleration time	Dec Time	0.0-600.0(s)	30.0	O/L	O	O	
06 ²	0h1106	Command source	Cmd Source	0 Keypad 1 Fx/Rx-1 2 Fx/Rx-2 3 Int 485 4 Field Bus	1: Fx/Rx-1	X/L	O	O	
07 ²	0h1107	Frequency reference source	Freq Ref Src	0 Keypad-1 1 Keypad-2 2 V1 4 V2 5 I2 6 Int 485 8 Field Bus 12 Pulse	0: Keypad-1	X/L	O	O	
08	0h1108	Torque reference setting	Trq Ref Src	0 Keypad-1 1 Keypad-2 2 V1 4 V2	0: Keypad-1	X/A	X	O	

² Displayed when an LCD keypad is in use.

Chapter 5. Table of Functions

Code	Comm. Address	Name	LCD Display	Setting Range	Initial value	Property*	V/F	SL	Ref.
				5 12					
				6 Int 485					
				8 FieldBus					
				12 Pulse					
09	0h1109	Control mode	Control Mode	0 V/F	0: V/F	X/A	O	O	
				2 Slip Compen					
				4 IM Sensorless					
10	0h110A	Torque Control	Torque Control	0 No	0: No	X/A	X	O	
				1 Yes					
11	0h110B	Jog frequency	Jog Frequency	0.00, Start frequency- Maximum frequency(Hz)	10.00	O/A	O	O	
12	0h110C	Jog run acceleration time	Jog Acc Time	0.0-600.0(s)	20.0	O/A	O	O	
13	0h110D	Jog run deceleration time	Jog Dec Time	0.0-600.0(s)	30.0	O/A	O	O	
14	0h110E	Motor capacity	Motor Capacity	0: 0.2kW, 1: 0.4kW 2: 0.75kW, 3: 1.1kW 4: 1.5kW, 5: 2.2kW 6: 3.0kW, 7: 3.7kW 8: 4.0kW, 9: 5.5kW 10: 7.5kW, 11: 11.0kW 12: 15.0kW, 13: 18.5kW 14: 22.0kW, 15: 30.0kW	Varies by Motor capacity	X/A	O	O	
15	0h110F	Torque boost options	Torque Boost	0 Manual	0: Manual	X/A	O	X	
				1 Auto					
16 ³	0h1110	Forward Torque boost	Fwd Boost	0.0-15.0(%)	2.0	X/A	O	X	
17 ³	0h1111	Reverse Torque boost	Rev Boost	0.0-15.0(%)	2.0	X/A	O	X	
18	0h1112	Base frequency	Base Freq	30.00-400.00(Hz)	60.00	X/A	O	O	
19	0h1113	Start frequency	Start Freq	0.01-10.00(Hz)	0.50	X/A	O	O	
20	0h1114	Maximum frequency	Max Freq	40.00- 400.00(Hz)[V/F, Slip Compen] 40.00-	60.00	X/A	O	O	

³ Displayed when dr.15 is set to 0 (Manual)

Code	Comm. Address	Name	LCD Display	Setting Range	Initial value	Property*	V/F	SL	Ref.
				120.00(Hz)[IM Sensorless]					
21	0h1115	Select speed unit	Hz/Rpm Sel	0 Hz Display 1 Rpm Display	0:Hz Display	O/L	O	O	
22 ⁴	0h1116	(+)Torque gain	(+)Trq Gain	50.0 ~ 150.0[%]	100.0	O/A	X	O	
23 ⁴	0h1117	(-)Torque gain	(-)Trq Gain	50.0 ~ 150.0[%]	80.0	O/A	X	O	
24 ⁴	0h1118	(-)Torque gain 0	(-)Trq Gain0	50.0 ~ 150.0[%]	80.0	O/A	X	O	
25 ⁴	0h1119	(-)Torque offset	(-)Trq Offset	0.0 ~ 100.0[%]	40.0	O/A	X	O	
80 ⁵	0h1150	Select ranges at power input	-	Select ranges inverter displays at power input 0 Run frequency 1 Acceleration time 2 Deceleration time 3 Command source 4 Frequency reference source 5 Multi-step speed frequency1 6 Multi-step speed frequency2 7 Multi-step speed frequency3 8 Output current 9 Motor RPM 10 Inverter DC voltage 11 User select signal (dr.81) 12 Currently out of order 13 Select run direction 14 output current2 15 Motor RPM2	0: run frequency	O/7	O	O	

⁴ Displayed when dr.10 is set to 1 (YES)

⁵ Will not be displayed when an LCD keypad is in use

Chapter 5. Table of Functions

Code	Comm. Address	Name	LCD Display	Setting Range	Initial value	Property*	V/F	SL	Ref.
				16 Inverter DC voltage2 17 User select signal2 (dr.81)					
81 ⁵	0h1151	Select monitor code	-	Monitors user selected code 0 Output voltage(V) 1 Output electric power(kW) 2 Torque(kgf·m)	0: output voltage	O/7	O	O	
89 ⁵	0h03E3	Display changed parameter	-	0 View All 1 View Changed	0: View All	O/7	O	O	
90 ⁵	0h115A	[ESC] key functions	-	0 Move to initial position 1 JOG Key 2 Local/Remote	0: None	X/7	O	O	
93 ⁵	0h115D	Parameter initialization	-	0 No 1 All Grp 2 dr Grp 3 bA Grp 4 Ad Grp 5 Cn Grp 6 In Grp 7 OU Grp 8 CM Grp 9 AP Grp 12 Pr Grp 13 M2 Grp 16 run Grp	0:No	X/7	O	O	
94 ⁵	0h115E	Password registration		0-99 99		O/7	O	O	
95 ⁵	0h115F	Parameter lock settings		0-99 99		O/7	O	O	
97 ⁵	0h1161	Software version	-			-/7	O	O	
98	0h1162	Display I/O board version	IO S/W Ver			-/A	O	O	
99	0h1163	Display I/O board H/W version	IO H/W Ver	0 Multiple IO 1 Standard IO 2 Standard IO (M)	Standard IO	-/A	O	O	

5.3 Basic Function group (PAR→bA)

In the following table, the data shaded in grey will be displayed when a related code has been selected.

SL: Sensorless vector control function (dr.09)

***O/X:** Write-enabled during operation, **7/L/A:** Keypad/LCD keypad/Common

Code	Comm. Address	Name	LCD Display	Setting Range	Initial Value	Property*	V/F	SL	Ref.	
00	-	Jump Code	Jump Code	1-99	20	O	O	O		
01	0h1201	Auxiliary reference source	Aux Ref Src	0	None	0:None	X/A	O	O	
				1	V1					
				3	V2					
				4	I2					
				6	Pulse					
02 ⁶	0h1202	Auxiliary command calculation type	Aux Calc Type	0	M+(G*A)	0: M+(GA)	X/A	O	O	
				1	Mx (G*A)					
				2	M/(G*A)					
				3	M+[M*(G*A)]					
				4	M+G*2(A-50%)					
				5	Mx[G*2(A-50%)					
				6	M/[G*2(A-50%)]					
				7	M+M*G*2(A-50%)					
03 ⁶	0h1203	Auxiliary command gain	Aux Ref Gain	-200.0-200.0(%)	100.0	O/A	O	O		
04	0h1204	2nd command source	Cmd 2nd Src	0	Keypad	1: Fx/Rx-1	X/A	O	O	
				1	Fx/Rx-1					
				2	Fx/Rx-2					
				3	Int 485					
				4	FieldBus					
05	0h1205	2nd frequency source	Freq 2nd Src	0	Keypad-1	0: Keypad-1	O/A	O	O	
				1	Keypad-2					
				2	V1					
				4	V2					
				5	I2					
				6	Int 485					
				8	FieldBus					
				12	Pulse					
06 ⁷	0h1206	2nd Torque command source	Trq 2nd Src	0	Keypad-1	0: Keypad-1	O	X	O	
				1	Keypad-2					
				2	V1					
				4	V2					
				5	I2					

⁶ Displayed if bA.01 is not set to 0 (None).

⁷ Displayed when dr.09 is set to 4(IM Sensorless)

Chapter 5. Table of Functions

Code	Comm. Address	Name	LCD Display	Setting Range		Initial Value	Property*	V/F	SL	Ref.
				6	Int 485					
				8	FieldBus					
				12	Pulse					
07	0h1207	V/F pattern options	V/F Pattern	0	Linear	0: Linear	X/A	O	X	
				1	Square					
				2	User V/F					
				3	Square 2					
08	0h1208	Acc/dec standard frequency	Ramp T Mode	0	Max Freq	0: Max Freq	X/A	O	O	
				1	Delta Freq					
09	0h1209	Time scale settings	Time Scale	0	0.01 sec	1:0.1 sec	X/A	O	O	
				1	0.1 sec					
				2	1 sec					
10	0h120A	Input power frequency	60/50 Hz Sel	0	60Hz	0:60Hz	X/A	O	O	
				1	50Hz					
11	0h120B	Number of motor poles	Pole Number	2-48			X/A	O	O	
12	0h120C	Rated slip speed	Rated Slip	0-3000(Rpm)		Dependent on motor setting	X/A	O	O	
13	0h120D	Motor rated current	Rated Curr	1.0-1000.0(A)			X/A	O	O	
14	0h120E	Motor noload current	Noload Curr	0.0-1000.0(A)			X/A	O	O	
15	0h120F	Motor rated voltage	Rated Volt	170-480(V)			0	X/A	O	O
16	0h1210	Motor efficiency	Efficiency	70-100(%)		Dependent on motor setting	X/A	O	O	
17	0h1211	Load inertia rate	Inertia Rate	0-8			X/A	O	O	
18	0h1212	Trim power display	Trim Power %	70-130(%)			O/A	O	O	
19	0h1213	Input power voltage	AC Input Volt	170-480V		220/380 V	O/A	O	O	
20	-	Auto Tuning	Auto Tuning	0	None	0:None	X/A	X	O	
				1	All (Rotation type)					
				2	ALL (Static type)					
				3	Rs+Lsigma (Rotation type)					
				6	Tr (Static type)					
21	-	Stator resistance	Rs			Dependent on motor setting	X/A	X	O	
22	-	Leakage inductance	Lsigma	Dependent on motor setting			X/A	X	O	
23	-	Stator inductance	Ls				X/A	X	O	
24 ⁷	-	Rotor time constant	Tr	25-5000(ms)		-	X/A	X	O	
25 ⁷	-	Stator inductance scale	Ls Scale	50 ~ 150[%]		100	X/A	X	O	

Code	Comm. Address	Name	LCD Display	Setting Range	Initial Value	Property*	V/F	SL	Ref.
26 ⁷	-	Rotor time constant scale	Tr Scale	50 ~ 150[%]	100	X/A	X	O	
31 ⁷		Regeneration inductance scale	Ls Regen Scale	70 ~ 100[%]	80	X/A	X	O	
41 ⁸	0h1229	User frequency1	User Freq 1	0.00-Maximum frequency(Hz)	15.00	X/A	O	X	
42 ⁸	0h122A	User voltage1	User Volt 1	0-100(%)	25	X/A	O	X	
43 ⁸	0h122B	User frequency2	User Freq 2	0.00-0.00-Maximum frequency(Hz)	30.00	X/A	O	X	
44 ⁸	0h122C	User voltage2	User Volt 2	0-100(%)	50	X/A	O	X	
45 ⁸	0h122D	User frequency3	User Freq 3	0.00-Maximum frequency(Hz)	45.00	X/A	O	X	
46 ⁸	0h122E	User voltage3	User Volt 3	0-100(%)	75	X/A	O	X	
47 ⁸	0h122F	User frequency4	User Freq 4	0.00-Maximum frequency(Hz)	Maximum frequency	X/A	O	X	
48 ⁸	0h1230	User voltage4	User Volt 4	0-100(%)	100	X/A	O	X	
50 ⁹	0h1232	Multi-step speed frequency1	Step Freq-1	0.00-Maximum frequency(Hz)	10.00	O/L	O	O	
51 ⁹	0h1233	Multi-step speed frequency2	Step Freq-2	0.00-Maximum frequency(Hz)	20.00	O/L	O	O	
52 ⁹	0h1234	Multi-step speed frequency3	Step Freq-3	0.00-Maximum frequency(Hz)	30.00	O/L	O	O	
53 ¹⁰	0h1235	Multi-step speed frequency4	Step Freq-4	0.00-Maximum frequency(Hz)	40.00	O/A	O	O	
54 ¹⁰	0h1236	Multi-step speed frequency5	Step Freq-5	0.00-Maximum frequency(Hz)	50.00	O/A	O	O	
55 ¹⁰	0h1237	Multi-step speed frequency6	Step Freq-6	0.00-Maximum frequency(Hz)	Maximum frequency	O/A	O	O	
56 ¹⁰	0h1238	Multi-step speed frequency7	Step Freq-7	0.00-Maximum frequency(Hz)	Maximum frequency	O/A	O	O	
70	0h1246	Multi-step acceleration time1	Acc Time-1	0.0-600.0(s)	20.0	O/A	O	O	
71	0h1247	Multi-step deceleration time1	Dec Time-1	0.0-600.0(s)	20.0	O/A	O	O	
72 ¹¹	0h1248	Multi-step	Acc Time-2	0.0-600.0(s)	30.0	O/A	O	O	

⁸ Displayed if either bA.07 or M2.25 is set to 2 (User V/F).

⁹ Displayed when an LCD keypad is in use.

¹⁰ Displayed if one of In.65-71 is set to Speed-L/M/H

¹¹ Displayed one of In.65-71 is set to Xcel-L/M/H.

Code	Comm. Address	Name	LCD Display	Setting Range	Initial Value	Property*	V/F	SL	Ref.
		acceleration time2							
73 ¹¹	0h1249	Multi-step deceleration time2	Dec Time-2	0.0-600.0(s)	30.0	O/A	O	O	
74 ¹¹	0h124A	Multi-step acceleration time3	Acc Time-3	0.0-600.0(s)	40.0	O/A	O	O	
75 ¹¹	0h124B	Multi-step deceleration time3	Dec Time-3	0.0-600.0(s)	40.0	O/A	O	O	
76 ¹¹	0h124C	Multi-step acceleration time4	Acc Time-4	0.0-600.0(s)	50.0	O/A	O	O	
77 ¹¹	0h124D	Multi-step deceleration time4	Dec Time-4	0.0-600.0(s)	50.0	O/A	O	O	
78 ¹¹	0h124E	Multi-step acceleration time5	Acc Time-5	0.0-600.0(s)	40.0	O/A	O	O	
79 ¹¹	0h124F	Multi-step deceleration time5	Dec Time-5	0.0-600.0(s)	40.0	O/A	O	O	
80 ¹¹	0h1250	Multi-step acceleration time6	Acc Time-6	0.0-600.0(s)	30.0	O/A	O	O	
81 ¹¹	0h1251	Multi-step deceleration time6	Dec Time-6	0.0-600.0(s)	30.0	O/A	O	O	
82 ¹¹	0h1252	Multi-step acceleration time7	Acc Time-7	0.0-600.0(s)	20.0	O/A	O	O	
83 ¹¹	0h1253	Multi-step deceleration time7	Dec Time-7	0.0-600.0(s)	20.0	O/A	O	O	

5.4 Expanded Function group (PAR→Ad)

In the following table, the data shaded in grey will be displayed when a related code has been selected.

SL: Sensorless vector control (dr.09)

***O/X:** Write-enabled during operation, **7/L/A:** Keypad/LCD keypad/Common

Code	Comm. Address	Name	LCD Display	Setting Range	Initial Value	Property*	V/F	SL	Ref.
00	-	Jump Code	Jump Code	1-99	24	O/A	O	O	
01	0h1301	Acceleration pattern	Acc Pattern	0 Linear	0: Linear	X/A	O	O	
02	0h1302	Deceleration	Dec Pattern	1 S-curve		X/A	O	O	

Code	Comm. Address	Name	LCD Display	Setting Range	Initial Value	Property*	V/F	SL	Ref.
		pattern							
03 ¹²	0h1303	S-curve acceleration start point gradient	Acc S Start	1-100(%)	40	X/A	O	O	
04 ¹²	0h1304	S-curve acceleration end point gradient	Acc S End	1-100(%)	40	X/A	O	O	
05 ¹³	0h1305	S-curve deceleration start point gradient	Dec S Start	1-100(%)	40	X/A	O	O	
06 ¹³	0h1306	S-curve deceleration end point gradient	Dec S End	1-100(%)	40	X/A	O	O	
07	0h1307	Start Mode	Start Mode	0 Acc 1 DC-Start	0:Acc	X/A	O	O	
08	0h1308	Stop Mode	Stop Mode	0 Dec 1 DC-Brake 2 Free-Run 4 Power Braking	0:Dec	X/A	O	O	
09	0h1309	Selection of prohibited rotation direction	Run Prevent	0 None 1 Forward Prev 2 Reverse Prev	0:None	X/A	O	O	
10	0h130A	Starting with power on	Power-on Run	0 No 1 Yes	0:No	O/A	O	O	
12 ¹⁴	0h130C	DC braking time at startup	DC-Start Time	0.00-60.00(s)	0.00	X/A	O	O	
13	0h130D	Amount of applied DC	DC Inj Level	0-200(%)	50	X/A	O	O	
14 ¹⁵	0h130E	Output blocking time before DC braking	DC-Block Time	0.00- 60.00(s)	0.10	X/A	O	O	
15 ¹⁵	0h130F	DC braking time	DC-Brake Time	0.00- 60.00(s)	1.00	X/A	O	O	
16 ¹⁵	0h1310	DC braking rate	DC-Brake Level	0-200(%)	50	X/A	O	O	
17 ¹⁵	0h1311	DC braking frequency	DC-Brake Freq	Start frequency-60Hz	5.00	X/A	O	O	
20	0h1314	Dwell frequency on acceleration	Acc Dwell Freq	Start frequency-Maximum frequency(Hz)	5.00	X/A	O	O	
21	0h1315	Dwell operation time on acceleration	Acc Dwell Time	0.0-60.0(s)	0.0	X/A	O	O	
22	0h1316	Dwell frequency	Dec Dwell	Start frequency-	5.00	X/A	O	O	

¹² Displayed when Ad. 01 is set to 1 (S-curve).

¹³ Displayed when Ad. 02 is set to 1 (S-curve).

¹⁴ Displayed when Ad. 07 is set to 1 (DC-Start).

¹⁵ Displayed when Ad. 08 is set to 1 (DC-Brake).

Chapter 5. Table of Functions

Code	Comm. Address	Name	LCD Display	Setting Range	Initial Value	Property [#]	V/F	SL	Ref.
		on deceleration	Freq	Maximum frequency(Hz)					
23	0h1317	Dwell operation time on deceleration	Dec Dwell Time	0.0-60.0(s)	0.0	X/A	O	O	
24	0h1318	Frequency limit	Freq Limit	0 No 1 Yes	0:No	X/A	O	O	
25 ¹⁶	0h1319	Frequency lower limit value	Freq Limit Lo	0.00-Upper limit frequency(Hz)	0.50	O/A	O	O	
26 ¹⁶	0h131A	Frequency upper limit value	Freq Limit Hi	Lower limit frequency-Maximum frequency(Hz)	maximum frequency	X/A	O	O	
27	0h131B	Frequency jump	Jump Freq	0 No 1 Yes	0:No	X/A	O	O	
28 ¹⁷	0h131C	Jump frequency lower limit1	Jump Lo 1	0.00-Jump frequency upper limit1(Hz)	10.00	O/A	O	O	
29 ¹⁷	0h131D	Jump frequency upper limit1	Jump Hi 1	Jump frequency lower limit1-Maximum frequency(Hz)	15.00	O/A	O	O	
30 ¹⁷	0h131E	Jump frequency lower limit2	Jump Lo 2	0.00-Jump frequency upper limit2(Hz)	20.00	O/A	O	O	
31 ¹⁷	0h131F	Jump frequency upper limit2	Jump Hi 2	Jump frequency lower limit2-Maximum frequency(Hz)	25.00	O/A	O	O	
32 ¹⁷	0h1320	Jump frequency lower limit3	Jump Lo 3	0.00-Jump frequency upper limit3(Hz)	30.00	O/A	O	O	
33 ¹⁷	0h1321	Jump frequency upper limit3	Jump Hi 3	Jump frequency lower limit3-Maximum frequency(Hz)	35.00	O/A	O	O	
41 ¹⁸	0h1329	Brake release current	BR Rls Curr	0.0-180.0(%)	50.0	O/A	O	O	
42 ¹⁸	0h132A	Brake release delay time	BR Rls Dly	0.00-10.00(s)	1.00	X/A	O	O	
44 ¹⁸	0h132C	Brake release Forward frequency	BR Rls Fwd Fr	0.00-Maximum frequency(Hz)	1.00	X/A	O	O	
45 ¹⁸	0h132D	Brake release Reverse frequency	BR Rls Rev Fr	0.00-Maximum frequency(Hz)	1.00	X/A	O	O	

¹⁶ Displayed when Ad. 24 is set to 1 (Yes).

¹⁷ Displayed when Ad. 27 is set to 1 (Yes).

¹⁸ Displayed if either OU.31 or OU.33 is set to 35 (BR Control).

Code	Comm. Address	Name	LCD Display	Setting Range	Initial Value	Property*	V/F	SL	Ref.
46 ¹⁸	0h132E	Brake engage delay time	BR Eng Dly	0.00-10.00(s)	1.00	X/A	O	O	
47 ¹⁸	0h132F	Brake engage frequency	BR Eng Fr	0.00-Maximum frequency(Hz)	2.00	X/A	O	O	
50	0h1332	Energy saving operation	E-Save Mode	0	None	0:None	X/A	O	X
				1	Manual				
				2	Auto				
51 ¹⁹	0h1333	Energy saving level	Energy Save	0-30(%)	0	O/A	O	X	
60	0h133C	Acc/Dec time transition frequency	Xcel Change Fr	0.00-Maximum frequency(Hz)	0.00	X/A	O	O	
64	0h1340	Cooling fan control	FAN Control	0	During Run	0:Durin g Run	O/A	O	O
				1	Always ON				
				2	Temp Control				
65	0h1341	Up/down operation frequency save	U/D Save Mode	0	No	0:No	O/A	O	O
				1	Yes				
66	0h1342	Output contact On/Off control options	On/Off Ctrl Src	0	None	0:None	X/A	O	O
				1	V1				
				3	V2				
				4	I2				
				6	Pulse				
67	0h1343	Output contact On level	On-Ctrl Level	Output contact off level- 100.00%	90.00	X/A	O	O	
68	0h1344	Output contact Off level	Off-Ctrl Level	-100.00-output contact on level (%)	10.00	X/A	O	O	
70	0h1346	Safe operation selection	Run En Mode	0	Always Enable	0:Alway s Enable	X/A	O	O
				1	DI Dependent				
71 ²⁰	0h1347	Safe operation stop options	Run Dis Stop	0	Free-Run	0:Free- Run	X/A	O	O
				1	Q-Stop				
				2	Q-Stop Resume				
72 ²⁰	0h1348	Safe operation deceleration time	Q-Stop Time	0.0-600.0(s)	5.0	O/A	O	O	
74	0h134A	Selection of regeneration evasion function for press	RegenAvd Sel	0	No	0:No	X/A	O	O
				1	Yes				
75	0h134B	Voltage level of regeneration evasion motion	RegenAvd Level	200V : 300-400V	350	X/A	O	O	
				400V : 600-800V	700				

¹⁹ Displayed if Ad.50 is not set to 0 (None).

²⁰ Displayed when Ad.70 is set to 1 (DI Dependent).

Chapter 5. Table of Functions

Code	Comm. Address	Name	LCD Display	Setting Range	Initial Value	Property*	V/F	SL	Ref.
		for press							
76 ²¹	0h134C	Compensation frequency limit of regeneration evasion for press	CompFreq Limit	0.00- 10.00Hz	1.00	X/A	O	O	
77 ²¹	0h134D	Regeneration evasion for press P gain	RegenAvd Pgain	0.0- 100.0%	50.0	O/A	O	O	
78 ²¹	0h134E	Regeneration evasion for press I gain	RegenAvd I gain	20-30000(ms)	500	O/A	O	O	
80	0h1350	Fire mode selection	Fire Mode Sel	0	None	0:None	X/A	O	X
				1	Fire Mode				
				2	Fire Mode Test				
81 ²²	0h1351	Fire mode frequency	Fire Mode Freq	0.00~60.00(Hz)	60.00	X/A	O	X	
82 ²²	0h1352	Fire mode direction	Fire Mode Dir	0	Forward	0: Forward	X/A	O	X
				1	Reverse				
83 ²²		Fire Mode Count	Fire Mode Cnt	Can not be modified					

²¹ Displayed when Ad.74 is set to 1 (Yes).

²² Displayed when Ad.80 is set to 1 (Yes).

5.5 Control Function group (PAR→Cn)

In the following table, the data shaded in grey will be displayed when a related code has been selected.

SL: Sensorless vector control (dr.09)

***O/X:** Write-enabled during operation, **7/L/A:** Keypad/LCD keypad/Common

Code	Comm. Address	Name	LCD Display	Setting Range	Initial Value	Property*	V/F	SL	Ref.
00	-	Jump Code	Jump Code	1-99	4	O/A	O	O	
04	0h1404	Carrier frequency	Carrier Freq	Heavy Duty	V/F: 1.0-15.0(kHz) ²³ SL: 2.0-15.0(kHz)	3.0	O/A	O	O
				Normal Duty	V/F: 1.0-5.0(kHz) ²⁴ SL: 2.0-5.0(kHz)	2.0			
05	0h1405	Switching mode	PWM Mode	0	Normal PWM	0:Normal PWM	X/A	O	O
				1	Lowleakage PWM				
09	0h1409	Initial excitation time	PreExTime	0.00-60.00(s)	1.00	X/A	X	O	
10	0h140A	Initial excitation amount	Flux Force	100.0-300.0(%)	100.0	X/A	X	O	
11	0h140B	Continued operation duration	Hold Time	0.00-60.00(s)	0.00	X/A	X	O	
20	0h1414	Sensorless 2 nd gain display setting	SL2 G View Sel	0	No	0:No	O/A	X	O
				1	Yes				
21	0h1415	Sensorless speed controller proportional gain1	ASR-SL P Gain1	0-5000(%)	Dependent on motor setting	O/A	X	O	
22	0h1416	Sensorless speed controller integral gain1	ASR-SL I Gain1	10-9999(ms)		O/A	X	O	
23 ²⁵	0h1417	Sensorless speed controller proportional gain2	ASR-SL P Gain2	1.0-1000.0(%)	Dependent on motor	O/A	X	O	

²³ In case of 0.4~4.0kW, the setting range is 2.0~15.0(kHz).

²⁴ In case of 0.4~4.0kW, the setting range is 2.0~5.0(kHz).

²⁵ Displayed when dr.09 is set to 4 (IM Sensorless) and Cn.20 is set to 1 (YES).

Chapter 5. Table of Functions

Code	Comm. Address	Name	LCD Display	Setting Range	Initial Value	Property*	V/F	SL	Ref.	
24 ²⁵	0h1418	Sensorless speed controller integral gain2	ASR-SL I Gain2	1.0-1000.0(%)	setting	O/A	X	O		
25 ²⁵	0h1419	Sensorless speed controller integral gain 0	ASR-SL I Gain0	1.0~999.9(ms)		O/A	X	O		
26 ²⁵	0h141A	Flux estimator proportional gain	Flux P Gain	10-200(%)		O/A	X	O		
27 ²⁵	0h141B	Flux estimator integral gain	Flux I Gain	10-200(%)		O/A	X	O		
28 ²⁵	0h141C	Speed estimator proportional gain	S-Est P Gain1	0-32767		O/A	X	O		
29 ²⁵	0h141D	Speed estimator integral gain1	S-Est I Gain1	100-1000		O/A	X	O		
30 ²⁵	0h141E	Speed estimator integral gain2	S-Est I Gain2	100-10000		O/A	X	O		
31 ²⁵	0h141F	Sensorless current controller proportional gain	ACR SL P Gain	10-1000		O/A	X	O		
32 ²⁵	0h1420	Sensorless current controller integral gain	ACR SL I Gain	10-1000	O/A	X	O			
48	-	Current controller P gain	ACR P Gain	0-10000	1200	O/A	X	O		
49	-	Current controller I gain	ACR I Gain	0-10000	120	O/A	X	O		
52	0h1434	Torque controller output filter	Torque Out LPF	0-2000(ms)	0	X/A	X	O		
53	0h1435	Torque limit setting options	Torque Lmt Src	0	Keypad-1	0: Keypad-1	X/A	X	O	
				1	Keypad-2					
				2	V1					
				4	V2					
				5	I2					
				6	Int 485					
				8	FieldBus					
				12	Pulse					
54 ²⁶	0h1436	Positive-direction reverse torque limit	FWD +Trq Lmt	0.0-200.0(%)	180	O/A	X	O		
55 ²⁶	0h1437	Positive-direction regeneration torque limit	FWD -Trq Lmt	0.0-200.0(%)	180	O/A	X	O		
56 ²⁶	0h1438	Negative-direction reverse torque limit	REV +Trq Lmt	0.0-200.0(%)	180	O/A	X	O		
57 ²⁶	0h1439	Negative-	REV -Trq Lmt	0.0-200.0(%)	180	O/A	X	O		

²⁶ Displayed when dr.09 is set to 4 (IM Sensorless). This will change the initial value of the parameter at Ad.74 (Torque limit) to 150%.

Code	Comm. Address	Name	LCD Display	Setting Range	Initial Value	Property*	V/F	SL	Ref.
		direction regeneration torque limit							
62 ²⁶	0h143E	Speed limit Setting	Speed Lmt Src	0	Keypad-1	0: Keypad-1	X/A	X	O
				1	Keypad-2				
				2	V1				
				4	V2				
				5	I2				
				6	Int 485				
				7	FieldBus				
63 ²⁶	0h143F	Positive-direction speed limit	FWD Speed Lmt	0.00~ Maximum frequency (Hz)	60.00	O/A	X	O	
64 ²⁶	0h1440	Negative-direction speed limit	REV Speed Lmt	0.00~ Maximum frequency (Hz)	60.00	O/A	X	O	
65 ²⁶	0h1441	Speed limit operation gain	Speed Lmt Gain	100~5000[%]	500	O/A	X	O	
70	0h1446	Speed search mode selection	SS Mode	0	Flying Start-1 ²⁷	0: Flying Start-1	X/A	O	O
				1	Flying Start-2				
71	0h1447	Speed search operation selection	Speed Search	bit	0000- 1111	0000 ²⁸	X/A	O	O
				0001	Selection of speed search on acceleration				
				0010	When starting on initialization after fault trip				
				0100	When restarting after instantaneous power interruption				
				1000	When starting with power on				
72 ²⁹	0h1448	Speed search reference current	SS Sup-Current	80-200(%)	150	O/A	O	O	
73 ³⁰	0h1449	Speed search proportional gain	SS P-Gain	0-9999	Flying Start-1 : 100	O/A	O	O	
					Flying Start-2 : 600 ³¹				

²⁷ Will not be displayed if dr.09 is set to 4 (IM Sensorless).

²⁸ The initial value 0000 will be displayed on the keypad as .

²⁹ Displayed when any of the Cn.71 code bits are set to 1 and Cn70 is set to 0 (Flying Start-1).

³⁰ Displayed when any of the Cn.71 code bits are set to 1.

³¹ The initial value is 1200 when the motor-rated capacity is less than 7.5 kW

Chapter 5. Table of Functions

Code	Comm. Address	Name	LCD Display	Setting Range	Initial Value	Property*	V/F	SL	Ref.
74 ³⁰	0h144A	Speed search integral gain	SS I-Gain	0-9999	Flying Start-1 : 200	O/A	O	O	
					Flying Start-2 : 1000				
75 ³⁰	0h144B	Output blocking time before speed search	SS Block Time	0.0-60.0(s)	1.0	X/A	O	O	
76 ³⁰	0h144C	Speed search Estimator gain	Spd Est Gain	50-150(%)	100	O/A	O	O	
77	0h144D	Energy buffering selection	KEB Select	0	No	0:No	X/A	O	O
				1	Yes				
78 ³²	0h144E	Energy buffering start level	KEB Start Lev	110.0-140.0(%)	125.0	X/A	O	O	
79 ³²	0h144F	Energy buffering stop level	KEB Stop Lev	125.0-145.0(%)	130.0	X/A	O	O	
80 ³²	0h1450	Energy buffering gain	KEB Gain	1-20000	1000	O/A	O	O	
85 ³³	0h1455	Flux estimator proportional gain1	Flux P Gain1	100-700	370	O/A	X	O	
86 ³³	0h1456	Flux estimator proportional gain2	Flux P Gain2	0-100	0	O/A	X	O	
87 ³³	0h1457	Flux estimator proportional gain3	Flux P Gain3	0-500	100	O/A	X	O	
88 ³³	0h1458	Flux estimator integral gain1	Flux I Gain1	0-200	50	O/A	X	O	
89 ³³	0h1459	Flux estimator integral gain2	Flux I Gain2	0-200	50	O/A	X	O	
90 ³³	0h145A	Flux estimator integral gain3	Flux I Gain3	0-200	50	O/A	X	O	
91 ³³	0h145B	Sensorless voltage compensation1	SL Volt Comp1	0-60	Dependent on motor setting	O/A	X	O	
92 ³³	0h145C	Sensorless voltage compensation2	SL Volt Comp2	0-60		O/A	X	O	
93 ³³	0h145D	Sensorless voltage compensation3	SL Volt Comp3	0-60		O/A	X	O	
94 ³³	0h145E	Sensorless field weakening start frequency	SL FW Freq	80.0-110.0(%)	100.0	X/A	X	O	

³² Displayed when Cn.77 is set to 1 (Yes).

³³ Displayed when Cn.20 is set to 1 (Yes).

Code	Comm. Address	Name	LCD Display	Setting Range	Initial Value	Property*	V/F	SL	Ref.
95 ³³	0h145F	Sensorless gain switching frequency	SL Fc Freq	0.00-8.00(Hz)	2.00	X/A	X	O	

5.6 Input Terminal Block Function group (PAR→In)

In the following table, the data shaded in grey will be displayed when a related code has been selected.

SL: Sensorless vector control (dr.09)

***O/X:** Write-enabled during operation, **7/L/A:** Keypad/LCD keypad/Common

Code	Comm. Address	Name	LCD Display	Setting Range	Initial Value	Property*	V/F	SL	Ref.
00	-	Jump Code	Jump Code	1-99	65	O/A	O	O	
01	0h1501	Frequency for maximum analog input	Freq at 100%	Start frequency- Maximum frequency(Hz)	Maximum frequency	O/A	O	O	
02	0h1502	Torque at maximum analog input	Torque at100%	0.0-200.0(%)	100.0	O/A	X	X	
05	0h1505	V1 input voltage display	V1 Monitor(V)	-12.00-12.00(V)	0.00	-/A	O	O	
06	0h1506	V1 input polarity selection	V1 Polarity	0	Unipolar	0: Unipolar	X/A	O	O
				1	Bipolar				
07	0h1507	Time constant of V1 input filter	V1 Filter	0-10000(ms)	10	O/A	O	O	
08	0h1508	V1 Minimum input voltage	V1 Volt x1	0.00-10.00(V)	0.00	O/A	O	O	
09	0h1509	V1 output at Minimum voltage (%)	V1 Perc y1	0.00-100.00(%)	0.00	O/A	O	O	
10	0h150A	V1 Maximum input voltage	V1 Volt x2	0.00-12.00(V)	10.00	O/A	O	O	
11	0h150B	V1 output at Maximum voltage (%)	V1 Perc y2	0.00-100.00(%)	100.00	O/A	O	O	
12 ³⁴	0h150C	V1 Minimum input voltage	V1 -Volt x1'	-10.00- 0.00(V)	0.00	O/A	O	O	
13 ³⁴	0h150D	V1 output at Minimum voltage (%)	V1 -Perc y1'	-100.00-0.00(%)	0.00	O/A	O	O	
14 ³⁴	0h150E	V1 Maximum input voltage	V1 -Volt x2'	-12.00- 0.00(V)	-10.00	O/A	O	O	

³⁴ Displayed when In.06 is set to 1 (Bipolar).

Chapter 5. Table of Functions

Code	Comm. Address	Name	LCD Display	Setting Range	Initial Value	Property [#]	V/F	SL	Ref.
15 ³⁴	0h150F	V1 output at Maximum voltage (%)	V1 -Perc y2'	-100.00-0.00(%)	-100.00	O/A	O	O	
16	0h1510	V1 rotation direction change	V1 Inverting	0 No 1 Yes	0: No	O/A	O	O	
17	0h1511	V1 quantization level	V1 Quantizing	0.00 ³⁵ , 0.04-10.00(%)	0.04	X/A	O	O	
35 ³⁶	0h1523	V2 input voltage display	V2 Monitor(V)	0.00-12.00(V)	0.00	-/A	O	O	
37 ³⁶	0h1525	V2 input filter time constant	V2 Filter	0-10000(ms)	10	O/A	O	O	
38 ³⁶	0h1526	V2 Minimum input voltage	V2 Volt x1	0.00-10.00(V)	0.00	O/A	X	X	
39 ³⁶	0h1527	V2 output at Minimum voltage (%)	V2 Perc y1	0.00-100.00(%)	0.00	O/A	O	O	
40 ³⁶	0h1528	V2 Maximum input voltage	V2 Volt x2	0.00-10.00(V)	10	O/A	X	X	
41 ³⁶	0h1529	V2 output at Maximum voltage (%)	V2 Perc y2	0.00-100.00(%)	100.00	O/A	O	O	
46 ³⁶	0h152E	V2 rotation direction change	V2 Inverting	0 No 1 Yes	0:No	O/A	O	O	
47 ³⁶	0h152F	V2 quantization level	V2 Quantizing	0.00 ³⁵ , 0.04- 10.00(%)	0.04	O/A	O	O	
50 ³⁷	0h1532	I2 input current display	I2 Monitor (mA)	0-24(mA)	0.00	-/A	O	O	
52 ³⁷	0h1534	I2 input filter time constant	I2 Filter	0-10000(ms)	10	O/A	O	O	
53 ³⁷	0h1535	I2 minimum input current	I2 Curr x1	0.00-20.00(mA)	4.00	O/A	O	O	
54 ³⁷	0h1536	I2 output at Minimum current (%)	I2 Perc y1	0.00-100.00(%)	0.00	O/A	O	O	
55 ³⁷	0h1537	I2 maximum input current	I2 Curr x2	0.00-24.00(mA)	20.00	O/A	O	O	
56 ³⁷	0h1538	I2 output at Maximum current (%)	I2 Perc y2	0.00-100.00(%)	100.00	O/A	O	O	
61 ³⁷	0h153D	Changing rotation direction of I2	I2 Inverting	0 No 1 Yes	0:No	O/A	O	O	
62 ³⁷	0h153E	I2 quantization level	I2 Quantizing	0.00 ³⁵ , 0.04-10.00(%)	0.04	O/A	O	O	
65	0h1541	P1 terminal	P1 Define	0 None	1:Fx	X/A	O	O	

³⁵ Quantizing is not used when set to 0.

³⁶ Displayed when V is selected on the analog current/voltage input circuit selection switch (SW2).



³⁷ Displayed when I is selected on the analog current/voltage input circuit selection switch (SW2).

Code	Comm. Address	Name	LCD Display	Setting Range		Initial Value	Property*	V/F	SL	Ref.
		function setting		1	Fx					
66	0h1542	P2 terminal function setting	P2 Define	2	Rx	2:Rx	X/A	O	O	
67	0h1543	P3 terminal function setting	P3 Define	3	RST	5:BX	X/A	O	O	
68	0h1544	P4 terminal function setting	P4 Define	4	External Trip	3:RST	X/A	O	O	
69	0h1545	P5 terminal function setting	P5 Define	5	BX	7:Sp-L	X/A	O	O	
70	0h1546	P6 terminal function setting	P6 Define	6	JOG	0:No	X/A	O	O	
71	0h1547	P7 terminal function setting	P7 Define	7	Speed-L	0:No	X/A	O	O	
72	0h1548	P8 terminal function setting	P8 Define	8	Speed-M	0:No	X/A	O	O	
73	0h1549	P9 terminal function setting	P9 Define	9	Speed-H	0:No	X/A	O	O	
74	0h154A	P10 terminal function setting	P10 Define	11	XCEL-L	0:No	X/A	O	O	
				12	XCEL-M					
				13	RUN Enable					
				14	3-Wire					
				15	2nd Source					
				16	Exchange					
				17	Up					
				18	Down					
				20	U/D Clear					
				21	Analog Hold					
				22	I-Term Clear					
				23	PID Openloop					
				24	P Gain2					
				25	XCEL Stop					
				26	2nd Motor					
				34	Pre Excite					
				38	Timer In					
				40	dis Aux Ref					
				46	FWD JOG					
				47	REV JOG					
				49	XCEL-H					
				50	User Seq					
				51	Fire Mode					
				54	TI ³⁸					
85	0h1555	Multi-function input terminal On filter	DI On Delay	0-10000(ms)		10	O/A	O	O	
86	0h1556	Multi-function	DI Off Delay	0-10000(ms)		3	O/A	O	O	

³⁸ Displayed when P5 is selected on Px terminal function.

Chapter 5. Table of Functions

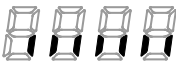
Code	Comm. Address	Name	LCD Display	Setting Range	Initial Value	Property*	V/F	SL	Ref.
		input terminal Off filter							
87	0h1557	Multi-function input contact selection	DI NC/NO Sel	P7 – P1	0 0000 ³⁹	X/A	O	O	
				0 A contact (NO)					
				1 B contact (NC)					
89	0h1559	Multi-step command delay time	InCheck Time	1-5000(ms)	1	X/A	O	O	
90	0h155A	Multi-function input terminal status	DI Status	P7 – P1	0 0000 ³⁹	-/A	O	O	
				0 release(Off)					
				1 Connection (On)					
91	0h155B	Pulse input amount display	Pulse Monitor (kHz)	0.00-50.00(kHz)	0.00	-/A	O	O	
92	0h155C	TI input filter time constant	TI Filter	0-9999(ms)	10	O/A	O	O	
93	0h155D	TI Minimum input pulse	TI Pls x1	0.00-32.00(kHz)	0.00	O/A	O	O	
94	0h153E	TI output at Minimum pulse (%)	TI Perc y1	0.00-100.00(%)	0.00	O/A	O	O	
95	0h155F	TI Maximum input pulse	TI Pls x2	0.00-32.00(kHz)	32.00	O/A	O	O	
96	0h1560	TI Output at Maximum pulse (%)	TI Perc y2	0-100(%)	100.00	O/A	O	O	
97	0h1561	TI rotation direction change	TI Inverting	0 No	0:No	O/A	O	O	
				1 Yes					
98	0h1562	TI quantization level	TI Quantizing	0.00 ³⁵ , 0.04-10.00(%)	0.04	O/A	O	O	
99	0h1563	SW1(NPN/PNP) SW2(V1/V2[I2]) status	IO SW State	Bit 00~11	00	-/A	O	O	
				00 V2, NPN					
				01 V2, PNP					
				10 I2, NPN					
				11 I2, PNP					

³⁹ The initial value 0000 will be displayed on the keypad as . The 7-seg screen of extension I/O displays  in case of clicking left and right key

5.7 Output Terminal Block Function group (PAR→OU)

In the following table, the data shaded in grey will be displayed when a related code has been selected.

SL: Sensorless vector control (dr.09)

***O/X:** Write-enabled during operation, **7/L/A:** Keypad/LCD keypad/Common

Code	Comm. Address	Name	LCD Display	Setting Range	Initial Value	Property*	V/F	SL	Ref.
00	-	Jump Code	JumpCode	1-99	30	O/A	O	O	
01	0h1601	Analog output 1 item	AO1 Mode	0	Frequency	0:Freque ncy	O/A	O	O
				1	Output Current				
				2	Output Voltage				
				3	DCLink Voltage				
				4	Torque				
				5	Output Power				
				6	Idse				
				7	Iqse				
				8	Target Freq				
				9	Ramp Freq				
				10	Speed Fdb				
				12	PID Ref Value				
				13	PID Fdb Value				
				14	PID Output				
				15	Constant				
02	0h1602	Analog output 1 gain	AO1 Gain	-1000.0-1000.0(%)	100.0	O/A	O	O	
03	0h1603	Analog output 1 bias	AO1 Bias	-100.0-100.0(%)	0.0	O/A	O	O	
04	0h1604	Analog output 1 filter	AO1 Filter	0-10000(ms)	5	O/A	O	O	
05	0h1606	Analog constant output 1	AO1 Const %	0.0-100.0(%)	0.0	O/A	O	O	
06	0h1606	Analog output 1 monitor	AO1 Monitor	0.0-1000.0(%)	0.0	-/A	O	O	
30	0h161E	Fault output item	Trip Out Mode	bit	000-111	010 ⁴⁰	O/A	O	O
				1	Low voltage				
				2	Any faults other than low voltage				
				3	Automatic restart final failure				
31	0h161F	Multi-function relay 1 item	Relay 1	0	None	29:Trip	O/A	O	O
				1	FDT-1				
				2	FDT-2				
				3	FDT-3				
				4	FDT-4				

⁴⁰ The initial value 0010 will be displayed on the keypad as .



Chapter 5. Table of Functions

Code	Comm. Address	Name	LCD Display	Setting Range	Initial Value	Property*	V/F	SL	Ref.
				5	Over Load				
				6	IOL				
				7	Under Load				
				8	Fan Warning				
				9	Stall				
				10	Over Voltage				
				11	Low Voltage				
				12	Over Heat				
				13	Lost Command				
				14	Run				
				15	Stop				
				16	Steady				
				17	Inverter Line				
				18	Comm Line				
				19	Speed Search				
				22	Ready				
				28	Timer Out				
				29	Trip				
				31	DB Warn%ED				
				34	On/Off Control				
33	0h1621	Multi-function output1 item	Q1 Define	0	None	14:Run	O/A	O	O
				1	FDT-1				
				2	FDT-2				
				3	FDT-3				
				4	FDT-4				
				5	Over Load				
				6	IOL				
				7	Under Load				
				8	Fan Warning				
				9	Stall				
				10	Over Voltage				
				11	Low Voltage				
				12	Over Heat				
				13	Lost Command				
				14	Run				
				15	Stop				
				16	Steady				
				17	Inverter Line				
				18	Comm Line				
				19	Speed Search				
22	Ready								
28	Timer Out								
29	Trip								
31	DB Warn%ED								
34	On/Off Control								

Code	Comm. Address	Name	LCD Display	Setting Range	Initial Value	Property*	V/F	SL	Ref.
				35	BR Control				
				36	CAP.Warning				
				37	FAN Exchange				
				38	Fire Mode				
				39	TO				
34	0h1622	Multi-function relay 3 item	Relay 3	0	None				
				1	FDT-1				
				2	FDT-2				
				3	FDT-3				
				4	FDT-4				
				5	Over Load				
				6	IOL				
				7	Under Load				
				8	Fan Warning				
				9	Stall				
				10	Over Voltage				
				11	Low Voltage				
				12	Over Heat				
				13	Lost Command				
				14	Run				
				15	Stop				
				16	Steady				
				17	Inverter Line				
				18	Comm Line				
				19	Speed Search				
				22	Ready				
				28	Timer Out				
				29	Trip				
31	DB Warn%ED								
34	On/Off Control								
35	BR Control								
36	CAP.Warning								
37	FAN Exchange								
38	Fire Mode								
35	0h1623	Multi-function relay 4 item	Relay 4	0	None				
				1	FDT-1				
				2	FDT-2				
				3	FDT-3				
				4	FDT-4				
				5	Over Load				
				6	IOL				
				7	Under Load				
				8	Fan Warning				
				9	Stall				
				10	Over Voltage				
				11	Low Voltage				
				12	Over Heat				
				13	Lost Command				
				14	Run				

Chapter 5. Table of Functions

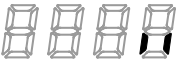
Code	Comm. Address	Name	LCD Display	Setting Range	Initial Value	Property*	V/F	SL	Ref.
				15 Stop					
				16 Steady					
				17 Inverter Line					
				18 Comm Line					
				19 Speed Search					
				22 Ready					
				28 Timer Out					
				29 Trip					
				31 DB Warn%ED					
				34 On/Off Control					
				35 BR Control					
				36 CAP.Warning					
				37 FAN Exchange					
				38 Fire Mode					
41	0h1629	Multi-function output monitor	DO Status	-	00	-/A	-	-	
50	0h1632	Multi-function output On delay	DO On Delay	0.00-100.00(s)	0.00	O/A	O	O	
51	0h1633	Multi-function output Off delay	DO Off Delay	0.00-100.00(s)	0.00	O/A	O	O	
52	0h1634	Multi-function output contact selection	DO NC/NO Sel	Q1, Relay1 0 A contact (NO) 1 B contact (NC)	00 ⁴¹	X/A	O	O	
53	0h1635	Fault output On delay	TripOut OnDly	0.00-100.00(s)	0.00	O/A	O	O	
54	0h1636	Fault output Off delay	TripOut OffDly	0.00-100.00(s)	0.00	O/A	O	O	
55	h1637	Timer On delay	TimerOn Delay	0.00-100.00(s)	0.00	O/A	O	O	
56	0h1638	Timer Off delay	TimerOff Delay	0.00-100.00(s)	0.00	O/A	O	O	
57	0h1639	Detected frequency	FDT Frequency	0.00-Maximum frequency(Hz)	30.00	O/A	O	O	
58	0h163A	Detected frequency band	FDT Band	0.00-Maximum frequency(Hz)	10.00	O/A	O	O	
61	0h163D	Pulse output gain	TO Mode	0 Frequency 1 Output Current 2 Output Voltage 3 DCLink Voltage 4 Torque 5 Output Power	0: Frequency	O/A	O	O	

⁴¹ The initial value 0000 will be displayed on the keypad as . The 7-seg screen of extension I/O displays  in case of clicking left and right key

Code	Comm. Address	Name	LCD Display	Setting Range	Initial Value	Property*	V/F	SL	Ref.
				6	Idse				
				7	Iqse				
				8	Target Freq				
				9	Ramp Freq				
				10	Speed Fdb				
				12	PID Ref Value				
				13	PID Fdb Value				
				14	PID Output				
				15	Constant				
62	0h163E	Pulse output gain	TO Gain	-1000.0-1000.0(%)		100.0	O/A	O	O
63	0h163F	Pulse output bias	TO Bias	-100.0-100.0(%)		0.0	O/A	O	O
64	0h1640	Pulse output filter	TO Filter	0-10000(ms)		5	O/A	O	O
65	0h1641	Pulse output constant output 2	TO Const %	0.0-100.0(%)		0.0	O/A	O	O
66	0h1642	Pulse output monitor	TO Monitor	0.0-1000.0(%)		0.0	-/A	O	O

5.8 Communication Function group (PAR→CM)

In the following table, the data shaded in grey will be displayed when a related code has been selected.

SL: Sensorless vector control (dr.09)

***O/X:** Write-enabled during operation, **7/L/A:** Keypad/LCD keypad/Common

Code	Comm. Address	Name	LCD Display	Setting Range	Initial Value	Property*	V/F	SL	Ref.	
00	-	Jump Code	Jump Code	1-99	20	O/A	O	O		
01	0h1701	Built-in communication inverter ID	Int485 St ID	1-250	1	O/A	O	O		
02 ⁴²	0h1702	Built-in communication protocol	Int485 Proto	0	0: ModBus RTU	O/A	O	O		
				2						LS Inv 485
03 ⁴²	0h1703	Built-in communication speed	Int485 BaudR	0	3: 9600 bps	O/A	O	O		
				1						2400 bps
				2						4800 bps
				3						9600 bps
				4						19200 bps
				5						38400 bps
				6						56 Kbps
				7	115 Kbps ⁴³					
04 ⁴²	0h1704	Built-in communication frame setting	Int485 Mode	0	0: D8/PN/S1	O/A	O	O		
				1						D8/PN/S2
				2						D8/PE/S1
				3						D8/PO/S1
05 ⁴²	0h1705	Transmission	Resp Delay	0-1000(ms)	5ms	O/A	O	O		

⁴² Will not be displayed when P2P and MultiKPD is set.

⁴³ 115,200bps

Chapter 5. Table of Functions

Code	Comm. Address	Name	LCD Display	Setting Range	Initial Value	Property [#]	V/F	SL	Ref.
		delay after reception							
06 ⁴⁴	0h1706	Communication option S/W version	FBus S/W Ver	-	0.00	O/A	O	O	
07 ⁴⁴	0h1707	Communication option inverter ID	FBus ID	0-255	1	O/A	O	O	
08 ⁴⁴	0h1708	FIELD BUS communication speed	FBUS BaudRate	-	12Mbps	-/A	O	O	
09 ⁴⁴	0h1709	Communication option LED status	FieldBus LED	-	-	O/A	O	O	
30	0h171E	Number of output parameters	ParaStatus Num	0-8	3	O/A	O	O	
31 ⁴⁵	0h171F	Output Communication address1	Para Stauts-1	0000-FFFF Hex	000A	O/A	O	O	
32 ⁴⁵	0h1720	Output Communication address2	Para Stauts-2	0000-FFFF Hex	000E	O/A	O	O	
33 ⁴⁵	0h1721	Output Communication address3	Para Stauts-3	0000-FFFF Hex	000F	O/A	O	O	
34 ⁴⁵	0h1722	Output Communication address4	Para Stauts-4	0000-FFFF Hex	0000	O/A	O	O	
35 ⁴⁵	0h1723	Output Communication address5	Para Stauts-5	0000-FFFF Hex	0000	O/A	O	O	
36 ⁴⁵	0h1724	Output Communication address6	Para Stauts-6	0000-FFFF Hex	0000	O/A	O	O	
37 ⁴⁵	0h1725	Output Communication address7	Para Stauts-7	0000-FFFF Hex	0000	O/A	O	O	
38 ⁴⁵	0h1726	Output Communication address8	Para Stauts-8	0000-FFFF Hex	0000	O/A	O	O	
50	0h1732	Number of input parameters	Para Ctrl Num	0-8	2	O/A	O	O	
51 ⁴⁶	0h1733	Input Communication address1	Para Control-1	0000-FFFF Hex	0005	X/A	O	O	
52 ⁴⁶	0h1734	Input	Para Control-2	0000-FFFF Hex	0006	X/A	O	O	

⁴⁴ Displayed only when a communication option card is installed.

⁴⁵ Only the range of addresses set at COM-30 is displayed.

⁴⁶ Only the range of addresses set at COM-50 is displayed.

Code	Comm. Address	Name	LCD Display	Setting Range		Initial Value	Property*	V/F	SL	Ref.
		Communication address2								
53 ⁴⁶	0h1735	Input Communication address3	Para Control-3	0000-FFFF Hex		0000	X/A	O	O	
54 ⁴⁶	0h1736	Input Communication address4	Para Control-4	0000-FFFF Hex		0000	X/A	O	O	
55 ⁴⁶	0h1737	Input Communication address5	Para Control-5	0000-FFFF Hex		0000	X/A	O	O	
56 ⁴⁶	0h1738	Input Communication address6	Para Control-6	0000-FFFF Hex		0000	X/A	O	O	
57 ⁴⁶	0h1739	Input Communication address7	Para Control-7	0000-FFFF Hex		0000	X/A	O	O	
58 ⁴⁶	0h173A	Input Communication address8	Para Control-8	0000-FFFF Hex		0000	X/A	O	O	
68	0h1744	Field bus data swap	FBus Swap Sel	0	No	0	X/A	O	O	
				1	Yes					
70	0h1746	Communication multi-function input 1	Virtual DI 1	0	None	0:None	O/A	O	O	
71	0h1747	Communication multi-function input 2	Virtual DI 2	1	Fx	0:None	O/A	O	O	
72	0h1748	Communication multi-function input 3	Virtual DI 3	2	Rx	0:None	O/A	O	O	
73	0h1749	Communication multi-function input 4	Virtual DI 4	3	RST	0:None	O/A	O	O	
74	0h174A	Communication multi-function input 5	Virtual DI 5	4	External Trip	0:None	O/A	O	O	
75	0h174B	Communication multi-function input 6	Virtual DI 6	5	BX	0:None	O/A	O	O	
76	0h174C	Communication multi-function input 7	Virtual DI 7	6	JOG	0:None	O/A	O	O	
77	0h174D	Communication multi-function input 8	Virtual DI 8	7	Speed-L	0:None	O/A	O	O	
				8	Speed-M					
				9	Speed-H					
				11	XCEL-L					
				12	XCEL-M					
				13	RUN Enable					
				14	3-Wire					

Chapter 5. Table of Functions

Code	Comm. Address	Name	LCD Display	Setting Range	Initial Value	Property*	V/F	SL	Ref.
				15	2nd Source				
				16	Exchange				
				17	Up				
				18	Down				
				20	U/D Clear				
				21	Analog Hold				
				22	I-Term Clear				
				23	PID Openloop				
				24	P Gain2				
				25	XCEL Stop				
				26	2nd Motor				
				34	Pre Excite				
				38	Timer In				
				40	dis Aux Ref				
				46	FWD JOG				
				47	REV JOG				
				49	XCEL-H				
86	0h1756	Communication multi-function input monitoring	Virt DI Status	-	0	X/A	O	O	
90	0h175A	Selection of data frame communication monitor	Comm Mon Sel	0	Int485	0	O/A	O	O
				1	KeyPad				
91	0h175B	Data frame Rev count	Rcv Frame Num	0~65535	0	O/A	O	O	
92	0h175C	Data frame Err count	Err Frame Num	0~65535	0	O/A	O	O	
93	0h175D	NAK frame count	NAK Frame Num	0~65535	0	O/A	O	O	
94 ⁴⁷	-	Communication data upload	Comm Update	0	No	0:No	-/A	O	O
				1	Yes				
95	0h1760	P2P communication selection	Int 485 Func	0	Disable All	0: Disable All	X/A	O	O
				1	P2P Master				
				2	P2P Slave				
				3	KPD-Ready				
96 ⁴⁸	-	DO setting selection	P2P OUT Sel	Bit	000~111	0:No	O/A	O	O
				001	Analog output				
				010	Multi-function relay				
				100	Multi-function output				

⁴⁷ Displayed only when a communication option card is installed.

⁴⁸ Displayed when AP.01 is set to 2 (Proc PID).

5.9 Application Function group (PAR→AP)

In the following table, the data shaded in grey will be displayed when a related code has been selected.

SL: Sensorless vector control (dr.09)

***O/X:** Write-enabled during operation, **7/L/A:** Keypad/LCD keypad/Common

Code	Comm. Address	Name	LCD Display	Setting Range	Initial Value	Property*	V/F	SL	Ref.
00	-	Jump Code	Jump Code	1-99	20	O/A	O	O	
01	0h1801	Application function selection	App Mode	0	None	0: None	X/A	O	O
				1	-				
				2	Proc PID				
02	-	Enable user sequence	User Seq En	0	No	0:No	X/A	O	O
				1	Yes				
16 ⁴⁹	0h1810	PID output monitor	PID Output	(%)	0.00	-/A	O	O	
17 ⁴⁹	0h1811	PID reference monitor	PID Ref Value	(%)	50.00	-/A	O	O	
18 ⁴⁹	0h1812	PID feedback monitor	PID Fdb Value	(%)	0.00	-/A	O	O	
19 ⁴⁹	0h1813	PID reference setting	PID Ref Set	-100.00-100.00(%)	50.00	O/A	O	O	
20 ⁴⁹	0h1814	PID reference source	PID Ref Source	0	Keypad	0: Keypad	X/A	O	O
				1	V1				
				3	V2				
				4	I2				
				5	Int 485				
				7	FieldBus				
				11	Pulse				
21 ⁴⁹	0h1815	PID feedback source	PID F/B Source	0	V1	0:V1	X/A	O	O
				2	V2				
				3	I2				
				4	Int 485				
				6	FieldBus				
				10	Pulse				
22 ⁴⁹	0h1816	PID controller proportional gain	PID P-Gain	0.0-1000.0(%)	50.0	O/A	O	O	
23 ⁴⁹	0h1817	PID controller integral time	PID I-Time	0.0-200.0(s)	10.0	O/A	O	O	
24 ⁴⁹	0h1818	PID controller differentiation time	PID D-Time	0-1000(ms)	0	O/A	O	O	
25 ⁴⁹	0h1819	PID controller feed-forward compensation gain	PID F-Gain	0.0-1000.0(%)	0.0	O/A	O	O	
26 ⁴⁹	0h181A	Proportional gain scale	P Gain Scale	0.0-100.0(%)	100.0	X/A	O	O	

⁴⁹ Displayed when AP.01 is set to 2 (Proc PID).

Chapter 5. Table of Functions

Code	Comm. Address	Name	LCD Display	Setting Range	Initial Value	Property*	V/F	SL	Ref.
27 ⁴⁹	0h181B	PID output filter	PID Out LPF	0-10000(ms)	0	O/A	O	O	
28 ⁴⁹	0h181C	PID Mode	PID Mode	0	Process PID	0	X/A	O	O
				1	Normal PID				
29 ⁴⁹	0h181D	PID upper limit frequency	PID Limit Hi	PID lower limit frequency-300.00(Hz)	60.00	O/A	O	O	
30 ⁴⁹	0h181E	PID lower limit frequency	PID Limit Lo	-300.00 -PID upper limit frequency(Hz)	-60.00	O/A	O	O	
31 ⁴⁹	0h181F	PID output inverse	PID Out Inv	0	No	0:No	X/A	O	O
				1	Yes				
32 ⁴⁹	0h1820	PID output scale	PID Out Scale	0.1-1000.0(%)	100.0	X/A	O	O	
34 ⁴⁹	0h1822	PID controller motion frequency	Pre-PID Freq	0.00- Maximum frequency(Hz)	0.00	X/A	O	O	
35 ⁴⁹	0h1823	PID controller motion level	Pre-PID Exit	0.0-100.0(%)	0.0	X/A	O	O	
36 ⁴⁹	0h1824	PID controller motion delay time	Pre-PID Delay	0-9999(s)	600	O/A	O	O	
37 ⁴⁹	0h1825	PID sleep mode delay time	PID Sleep DT	0.0-999.9(s)	60.0	O/A	O	O	
38 ⁴⁹	0h1826	PID sleep mode frequency	PID Sleep Freq	0.00- Maximum frequency(Hz)	0.00	O/A	O	O	
39 ⁴⁹	0h1827	PID wake-up level	PIDWakeUp Lev	0-100(%)	35	O/A	O	O	
40 ⁴⁹	0h1828	PID wake-up mode setting	PID WakeUp Mod	0	Below Level	0:Below Level	O/A	O	O
				1	Above Level				
				2	Beyond Level				
42 ⁴⁹	0h182A	PID controller unit selection	PID Unit Sel	0	%	0:%	O/A	O	O
				1	Bar				
				2	mBar				
				3	Pa				
				4	kPa				
				5	Hz				
				6	rpm				
				7	V				
				8	I				
				9	kW				
				10	HP				
				11	°C				
12	°F								
43 ⁴⁹	0h182B	PID unit gain	PID Unit Gain	0.00-300.00(%)	100.00	O/A	O	O	
44 ⁴⁹	0h182C	PID unit scale	PID Unit Scale	0	x100	2:x 1	O/A	O	O
				1	x10				

Code	Comm. Address	Name	LCD Display	Setting Range		Initial Value	Property*	V/F	SL	Ref.
				2	x 1					
				3	x 0.1					
				4	x 0.01					
45 ⁴⁹	0h182D	PID 2nd proportional gain	PID P2-Gain	0.0-1000.0(%)		100.0	X/A	O	O	

5.10 Extension I/O Function Group(PAR→AO)

In the following table, the data shaded in grey will be displayed when a related code has been selected.

SL: Sensorless vector control (dr.09)

***O/X:** Write-enabled during operation, **7/L/A:** Keypad/LCD keypad/Common

코드	통신 번지	명칭	LCD 표시	설정 범위	초기 값	속성*	V/F	SL	참조
00	-	Jum Code	Jump Code	1~99	0	O/A	O	O	
01	0h1A01	V3 input voltage display	V3 Monitor[V]	-12.00 ~ 12.00[V]	0.00	-/A	O	O	
02	0h1A02	V3 input polarity selection	V3 Polarity	0 Unipolar 1 Bipolar	0:Unipolar	X/A	O	O	
03	0x1A03	Time constant of V3 input filter	V3 Filter	0 ~ 10000[ms]	10	O/A	O	O	
04	0x1A04	V3 Minimum input voltage	V3 Volt x1	0.00 ~ 10.00[V]	0.00	O/A	O	O	
05	0x1A05	V3 output at Minimum voltage (%)	V3 Perc y1	0.00 ~ 100.00[%]	0.00	O/A	O	O	
06	0x1A06	V3 Maximum input voltage	V3 Volt x2	0.00 ~ 12.00[V]	10.00	O/A	O	O	
07	0x1A07	V3 output at Maximum voltage (%)	V3 Perc y2	0.00 ~ 100.00[%]	100.00	O/A	O	O	
08	0x1A08	V3 rotation direction change	V3 Inverting	0 No 1 Yes	0:No	O/A	O	O	
09	0x1A09	V3 quantization level	V3 Quantizing	0.00, 0.04 ~ 10.00[%]	0.04	X/A	O	O	
10	0x1A0A	V3 Minimum input voltage	V3 -Volt x1'	-10.00~ 0.00[V]	0.00	O/A	O	O	
11	0x1A0B	V3 output at Minimum voltage (%)	V3 -Perc y1'	-100.00 ~ 0.00[%]	0.00	O/A	O	O	
12	0x1A0C	V3 Maximum input voltage	V3 -Volt x2'	-12.00~ 0.00[V]	-10.00	O/A	O	O	
13	0x1A0D	V3 output at Maximum voltage (%)	V3 -Perc y2'	-100.00 ~ 0.00[%]	-100.00	O/A	O	O	
14	0x1A0E	V4 input voltage display	V4 Monitor[V]	0.00 ~ 12.00[V]	0.00	-/A	O	O	

Chapter 5. Table of Functions

코드	통신 번지	명칭	LCD 표시	설정 범위	초기 값	속성*	V/F	SL	참조
15	0x1A0F	Time constant of V4 input filter	V4 Filter	0 ~ 10000[ms]	10	O/A	O	O	
16	0x1A10	V4 Minimum input voltage	V4 Volt x1	0.00 ~ 10.00[V]	0.00	O/A	X	X	
17	0x1A11	V4 output at Minimum voltage (%)	V4 Perc y1	0.00 ~ 100.00[%]	0.00	O/A	O	O	
18	0x1A12	V4 Maximum input voltage	V4 Volt x2	0.00 ~ 10.00[V]	10	O/A	X	X	
19	0x1A13	V4 output at Maximum voltage (%)	V4 Perc y2	0.00 ~ 100.00[%]	100.00	O/A	O	O	
20	0x1A14	V4 rotation direction change	V4 Inverting	0	No	0:No	O/A	O	O
				1	Yes				
21	0x1A15	V4 quantization level	V4 Quantizing	0.0050, 0.04~10.00[%]	0.04	O/A	O	O	
22	0x1A16	I4 input current display	I4 Monitor[mA]	0 ~ 24[mA]	0.00	-/A	O	O	
23	0x1A17	I4 input filter time constant	I4 Filter	0 ~ 10000[ms]	10	O/A	O	O	
24	0x1A18	I4 minimum input current	I4 Curr x1	0.00 ~ 20.00[mA]	4.00	O/A	O	O	
25	0x1A19	I4 output at Minimum current (%)	I4 Perc y1	0.00 ~ 100.00[%]	0.00	O/A	O	O	
26	0x1A1A	I4 maximum input current	I4 Curr x2	0.00 ~ 24.00[mA]	20.00	O/A	O	O	
27	0x1A1B	I4 output at Maximum current (%)	I4 Perc y2	0.00 ~ 100.00[%]	100.00	O/A	O	O	
28	0x1A1C	Changing rotation direction of I4	I4 Inverting	0	No	0:No	O/A	O	O
				1	Yes				
29	0x1A1D	I4 quantization level	I4 Quantizing	0.0051, 0.04 ~ 10.00[%]	0.04	O/A	O	O	
30	0x1A1E	Analog output 3 item	AO3 Mode	0	Frequency	0: Frequency	O/A	O	O
				1	Output Current				
				2	Output Voltage				
				3	DCLink Voltage				
				4	Torque				
				5	Output Power				
				6	Idse				
				7	Iqse				
				8	Target Freq				
				9	Ramp Freq				

⁵⁰ 0을 설정 하면 Quantizing 사용하지 않습니다.

⁵¹ 0을 설정 하면 Quantizing 사용하지 않습니다.

코드	통신 번지	명칭	LCD 표시	설정 범위	초기 값	속성*	V/F	SL	참조
				10 Speed Fdb					
				12 PID Ref Value					
				13 PID Fdb Value					
				14 PID Output					
				15 Constant					
31	0x1A1F	Analog output 5 gain	AO5 gain	-1000.0 ~ 1000.0[%]	100.0	O/A	O	O	
32	0x1A20	Analog output 5 bias	AO5 Bias	-100.0 ~ 100.0[%]	0.0	O/A	O	O	
33	0x1A21	Analog output 5 filter	AO5 Filter	0 ~ 10000[ms]	5	O/A	O	O	
34	0x1A22	Analog constant output 5	AO5 Const %	0.0 ~ 100.0[%]	0.0	O/A	O	O	
35	0x1A23	Analog output 5 monitor	AO5 Monitor	0.0 ~ 1000.0[%]	0.0	-/A	O	O	
36	0x1A24	Ext IO Switch	Ext IO Switch	00 NPN,V4	01	-/A	-	-	
				01 NPN,I4					
				10 PNP,V4					
				11 PNP,I4					
37	0x1A25	Ext I/O SW Ver	Ext I/O SW Ver	-	1.00	-/A	-	-	

5.11 Protection Function group (PAR→Pr)

In the following table, the data shaded in grey will be displayed when a related code has been selected.

SL: Sensorless vector control (dr.09)

***O/X:** Write-enabled during operation, **7/L/A:** Keypad/LCD keypad/Common

Code	Comm. Address	Name	LCD Display	Setting Range	Initial Value	Property*	V/F	SL	Ref.
00	-	Jump Code	Jump Code	1-99	40	O/A	O	O	
04	0h1B04	Load level setting	Load Duty	0 Normal Duty	1:Heavy Duty	X/A	O	O	
				1 Heavy Duty					
05	0h1B05	Input/output open-phase protection	Phase Loss Chk	bit 00-11	00 ⁵²	X/A	O	O	
				01 Output open phase					
				10 Input open phase					

⁵² The initial value 0000 will be displayed on the keypad as .

Chapter 5. Table of Functions

Code	Comm. Address	Name	LCD Display	Setting Range	Initial Value	Property*	V/F	SL	Ref.
06	0h1B06	Input voltage range during open-phase	IPO V Band	1-100(V)	15	X/A	O	O	
07	0h1B07	Deceleration time at fault trip	Trip Dec Time	0.0-600.0(s)	3.0	O/A	O	O	
08	0h1B08	Selection of startup on trip reset	RST Restart	0	No	0:No	O/A	O	O
				1	Yes				
09	0h1B09	Number of automatic restarts	Retry Number	0-10	0	O/A	O	O	
10 ⁵³	0h1B0A	Automatic restart delay time	Retry Delay	0.0-60.0(s)	1.0	O/A	O	O	
12	0h1B0C	Motion at speed command loss	Lost Cmd Mode	0	None	0:None	O/A	O	O
				1	Free-Run				
				2	Dec				
				3	Hold Input				
				4	Hold Output				
				5	Lost Preset				
13 ⁵⁴	0h1B0D	Time to decide speed command loss	Lost Cmd Time	0.1-120(s)	1.0	O/A	O	O	
14 ⁵⁴	0h1B0E	Operation frequency at speed command loss	Lost Preset F	Start frequency- Maximum frequency(Hz)	0.00	O/A	O	O	
15 ⁵⁴	0h1B0F	Analog input loss decision level	AI Lost Level	0	Half x1	0:Half of x1	O/A	O	O
				1	Below x1				
17	0h1B11	Overload warning selection	OL Warn Select	0	No	0:No	O/A	O	O
				1	Yes				
18	0h1B12	Overload alarm level	OL Warn Level	30-180(%)	150	O/A	O	O	
19	0h1B13	Overload warning time	OL Warn Time	0.0-30.0(s)	10.0	O/A	O	O	
20	0h1B14	Motion at overload fault	OL Trip Select	0	None	1:Free-Run	O/A	O	O
				1	Free-Run				
				2	Dec				

⁵³ Displayed when Pr.09 is set higher than 0.

⁵⁴ Displayed when Pr.12 is not set to 0 (NONE).

Code	Comm. Address	Name	LCD Display	Setting Range	Initial Value	Property*	V/F	SL	Ref.
21	0h1B15	Overload fault level	OL Trip Level	30-200(%)	180	O/A	O	O	
22	0h1B16	Overload fault time	OL Trip Time	0.0-60.0(s)	60.0	O/A	O	O	
25	0h1B19	Underload warning selection	UL Warn Sel	0	No	0:No	O/A	O	O
				1	Yes				
26	0h1B1A	Underload warning time	UL Warn Time	0.0-600.0(s)	10.0	O/A	O	O	
27	0h1B1B	Underload fault selection	UL Trip Sel	0	None	0:None	O/A	O	O
				1	Free-Run				
				2	Dec				
28	0h1B1C	Underload fault time	UL Trip Time	0.0-600.0(s)	30.0	O/A	O	O	
29	0h1B1D	Underload lower limit level	UL LF Level	10-30(%)	30	O/A	O	O	
30	0h1B1E	Underload upper limit level	UL BF Level	30-100(%)	30	O/A	O	O	
31	0h1B1F	No motor motion at detection	No Motor Trip	0	None	0:None	O/A	O	O
				1	Free-Run				
32	0h1B20	No motor detection current level	No Motor Level	1-100(%)	5	O/A	O	O	
33	0h1B21	No motor detection delay	No Motor Time	0.1-10.0(s)	3.0	O/A	O	O	
40	0h1B28	Electronic thermal fault selection	ETH Trip Sel	0	None	0:None	O/A	O	O
				1	Free-Run				
				2	Dec				
41	0h1B29	Motor cooling fan type	Motor Cooling	0	Self-cool	0:Self-cool	O/A	O	O
				1	Forced-cool				
42	0h1B2A	Electronic thermal 1 minute rating	ETH 1min	120-200(%)	150	O/A	O	O	
43	0h1B2B	Electronic thermal continuous rating	ETH Cont	50-150(%)	120	O/A	O	O	
45	0h1B2D	BX trip mode	BX Mode	0	Free-Run	0	X/A	O	O
				1	Dec				
50	0h1B32	Stall prevention motion and flux braking	Stall Prevent	bit	0000-1111	1000	X/A	O	O
				000 1	Accelerating				
				001 0	At constant speed				
				010 0	At deceleration				

Chapter 5. Table of Functions

Code	Comm. Address	Name	LCD Display	Setting Range	Initial Value	Property*	V/F	SL	Ref.
				100 0 FluxBraking					
51	0h1B33	Stall frequency1	Stall Freq 1	Start frequency- Stall frequency2(Hz)	60.00	O/A	O	O	
52	0h1B34	Stall level1	Stall Level 1	30-250(%)	180	X/A	O	O	
53	0h1B35	Stall frequency2	Stall Freq 2	Stall frequency1- Stall frequency3(Hz)	60.00	O/A	O	O	
54	0h1B36	Stall level2	Stall Level 2	30-250(%)	180	X/A	O	O	
55	0h1B37	Stall frequency3	Stall Freq 3	Stall frequency2- Stall frequency4(Hz)	60.00	O/A	O	O	
56	0h1B38	Stall level3	Stall Level 3	30-250(%)	180	X/A	O	O	
57	0h1B39	Stall frequency4	Stall Freq 4	Stall frequency3- Maximum frequency(Hz)	60.00	O/A	O	O	
58	0h1B3A	Stall level4	Stall Level 4	30-250(%)	180	X/A	O	O	
59	0h1B3B	Flux braking gain	Flux Brake Kp	0 ~ 150[%]	0	O/A	O	O	
60	0h1B3C	CAP diagnosis level	CAP. Diag Perc	10 ~ 100[%]	0	O/A	O	O	
61 ⁵⁵	0h1B3D	CAP diagnosis mode	CAP. Diag	0	None	0	X/A	O	
				1	Ref Diag				
				2	Pre Diag				
				3	Init Diag				
62 ⁵⁵	0h1B3E	CAP Exchange Level	CAP Exchange Level	50.0 ~ 95.0[%]	0	X/A	O	O	
63 ⁵⁵	0h1B3F	CAP Diag Level	CAP Diag Level	0.0~100.0[%]	100.0	-/A	O	O	
66	0h1B42	DB resistor warning level	DB Warn %ED	0-30(%)	0	O/A	O	O	
73	0h1B22	Speed deviation trip	Speed Dev Trip	0	No	0:No	O/A	O	O
				1	Yes				
74	0h1B23	Speed deviation band	Speed Dev Band	1 ~ 20	5	O/A	O	O	
75	0h1B24	Speed deviation time	Speed Dev Time	0 ~ 120	60	O/A	O	O	
79	0h1B4F	Cooling fan fault selection	FAN Trip Mode	0	Trip	0:Trip	O/A	O	O
				1	Warning				
80	0h1B50	Motion selection at option trip	Opt Trip Mode	0	None	1:Free-Run	O/A	O	O
				1	Free-Run				
				2	Dec				

⁵⁵ The Pr.61-63 codes are displayed when the Pr.60(CAP.DiagPrec) is set to more than 0.

Code	Comm. Address	Name	LCD Display	Setting Range	Initial Value	Property*	V/F	SL	Ref.
81	0h1B51	Low voltage fault decision delay time	LVT Delay	0.0-60.0(s)	0.0	X/A	O	O	
82	0h1B52	LV2 Selection	LV2 Enable	0	No	0	X/A	O	O
				1	Yes				
86	0h1B56	Accumulated percent of fan usage	Fan Time Perc	0.0~100.0[%]	0.0	-/A	O	O	
87	0h1B57	Fan exchange warning level	Fan Exchange level	0.0~100.0[%]	90.0	O/A	O	O	
88 ⁵⁶	0h1B58	Fan reset time	Fan Time Rst	0	No	0	X/A	O	O
				1	Yes				
89	0h1B59	CAP, FAN Status	CAP, FAN State	Bit	00~10	0	-/A	O	O
				00	-				
				01	CAP Warning				
				10	FAN Warning				
90 ⁵⁶	0h1B5A	Warning information	-	-	-	-/7	O	O	
91 ⁵⁶	0h1B5B	Fault history 1	-	-	-	-/7	O	O	
92 ⁵⁶	0h1B5C	Fault history 2	-	-	-	-/7	O	O	
93 ⁵⁶	0h1B5D	Fault history 3	-	-	-	-/7	O	O	
94 ⁵⁶	0h1B5E	Fault history 4	-	-	-	-/7	O	O	
95 ⁵⁶	0h1B5F	Fault history 5	-	-	-	-/7	O	O	
96 ⁵⁶	0h1B60	Fault history deletion	-	0	No	0:No	-/7	O	O
				1	Yes				

⁵⁶ Will not be displayed when an LCD keypad is in use.

5.12 2nd Motor Function group (PAR→M2)

The 2nd Motor function group will be displayed if any of In.65-71 are set to 26 (2nd MOTOR). In the following table, the data shaded in grey will be displayed when a related code has been selected.

SL: Sensorless vector control (dr.09)

***O/X:** Write-enabled during operation, **7/L/A:** Keypad/LCD keypad/Common

Code	Comm. Address	Name	LCD Display	Setting Range	Initial Value	Property*	V/F	SL	Ref.
00	-	Jump Code	Jump Code	1-99	14	O/A	O	O	
04	0h1C04	Acceleration time	M2-Acc Time	0.0-600.0(s)	20.0	O/A	O	O	
05	0h1C05	Deceleration time	M2-Dec Time	0.0-600.0(s)	30.0	O/A	O	O	
06	0h1C06	Motor capacity	M2-Capacity	0	0.2 kW	-	X/A	O	O
				1	0.4 kW				
				2	0.75 kW				
				3	1.1 kW				
				4	1.5 kW				
				5	2.2 kW				
				6	3.0 kW				
				7	3.7 kW				
				8	4.0 kW				
				9	5.5 kW				
				10	7.5 kW				
				11	11.0 kW				
				12	15.0 kW				
				13	18.5 kW				
				14	22.0 kW				
15	30.0 kW								
07	0h1C07	Base frequency	M2-Base Freq	30.00-400.00(Hz)	60.00	X/A	O	O	
08	0h1C08	Control mode	M2-Ctrl Mode	0	V/F	0:V/F	X/A	O	O
				2	Slip Compen				
				4	IM Sensorless				
10	0h1C0A	Number of motor poles	M2-Pole Num	2-48	Dependent on motor settings	X/A	O	O	
11	0h1C0B	Rated slip speed	M2-Rated Slip	0-3000(rpm)		X/A	O	O	
12	0h1C0C	Motor rated current	M2-Rated Curr	1.0-1000.0(A)		X/A	O	O	
13	0h1C0D	Motor no-load current	M2-Noload Curr	0.5-1000.0(A)		X/A	O	O	
14	0h1C0E	Motor rated voltage	M2-Rated Volt	170-480(V)		X/A	O	O	
15	0h1C0F	Motor efficiency	M2-Efficiency	70-100(%)		X/A	O	O	
16	0h1C10	Load inertia rate	M2-Inertia Rt	0-8		X/A	O	O	
17	-	Stator resistance	M2-Rs	Dependent on motor settings		X/A	O	O	
18	-	Leakage inductance	M2-Lsigma		X/A	O	O		

Code	Comm. Address	Name	LCD Display	Setting Range	Initial Value	Property*	V/F	SL	Ref.
19	-	Stator inductance	M2-Ls			X/A	O	O	
20 ⁵⁷	-	Rotor time constant	M2-Tr	25-5000(ms)		X/A	O	O	
25	0h1C19	V/F pattern	M2-V/F Patt	0	Linear	0: Linear	X/A	O	O
				1	Square				
				2	User V/F				
26	0h1C1A	Forward Torque boost	M2-Fwd Boost	0.0-15.0(%)	2.0	X/A	O	O	
27	0h1C1B	Reverse Torque boost	M2-Rev Boost	0.0-15.0(%)		X/A	O	O	
28	0h1C1C	Stall prevention level	M2-Stall Lev	30-150(%)	150	X/A	O	O	
29	0h1C1D	Electronic thermal 1 minute rating	M2-ETH 1min	100-200(%)	150	X/A	O	O	
30	0h1C1E	Electronic thermal continuous rating	M2-ETH Cont	50-150(%)	100	X/A	O	O	

⁵⁷ Displayed when M2.08 is set to 4 (IM Sensorless).

5.13 User Sequence group (US)

This group appears when AP02 is set to 1 (Yes) or CM.95 is set to 2 (P2P Master). The parameter cannot be changed while the user sequence is running.

SL: Sensorless vector control function (dr.09)

***O/X:** Write-enabled during operation, **7/L/A:** keypad/LCD keypad/common

Code	Comm. Address	Name	LCD Display	Setting Range	Initial Value	Property*	V/F	SL	Ref.
00	-	Jump code	Jump Code	1-99	31	O/A	O	O	
01	0h1D01	User sequence operation command	User Seq Con	0	Stop	0:Stop	X/A	O	O
				1	Run				
				2	Digital In Run				
02	0h1D02	User sequence operation loop time	US Loop Time	0	0.01s	1:0.02s	X/A	O	O
				1	0.02s				
				2	0.05s				
				3	0.1s				
				4	0.5s				
				5	1s				
11	0h1D0B	Output address link1	Link UserOut1	0-0xFFFF	0	X/A	O	O	
12	0h1D0C	Output address link2	Link UserOut2	0-0xFFFF	0	X/A	O	O	
13	0h1D0D	Output address link3	Link UserOut3	0-0xFFFF	0	X/A	O	O	
14	0h1D0E	Output address link4	Link UserOut4	0-0xFFFF	0	X/A	O	O	
15	0h1D0F	Output address link5	Link UserOut5	0-0xFFFF	0	X/A	O	O	
16	0h1D10	Output address link6	Link UserOut6	0-0xFFFF	0	X/A	O	O	
17	0h1D11	Output address link7	Link UserOut7	0-0xFFFF	0	X/A	O	O	
18	0h1D12	Output address link8	Link UserOut8	0-0xFFFF	0	X/A	O	O	
19	0h1D13	Output address link9	Link UserOut9	0-0xFFFF	0	X/A	O	O	
20	0h1D14	Output address link10	Link UserOut10	0-0xFFFF	0	X/A	O	O	
21	0h1D15	Output address link11	Link UserOut11	0-0xFFFF	0	X/A	O	O	
22	0h1D16	Output address link12	Link UserOut12	0-0xFFFF	0	X/A	O	O	
23	0h1D17	Output address link13	Link UserOut13	0-0xFFFF	0	X/A	O	O	
24	0h1D18	Output address link14	Link UserOut14	0-0xFFFF	0	X/A	O	O	
25	0h1D19	Output address link15	Link UserOut15	0-0xFFFF	0	X/A	O	O	
26	0h1D1A	Output address link16	Link UserOut16	0-0xFFFF	0	X/A	O	O	
27	0h1D1B	Output address link17	Link UserOut17	0-0xFFFF	0	X/A	O	O	
28	0h1D1C	Output address link18	Link UserOut18	0-0xFFFF	0	X/A	O	O	
31	0h1D1F	Input constant setting1	Void Para1	-9999-9999	0	X/A	O	O	
32	0h1D20	Input constant setting2	Void Para2	-9999-9999	0	X/A	O	O	

Code	Comm. Address	Name	LCD Display	Setting Range	Initial Value	Property*	V/F	SL	Ref.
33	0h1D21	Input constant setting3	Void Para3	-9999-9999	0	X/A	O	O	
34	0h1D22	Input constant setting4	Void Para4	-9999-9999	0	X/A	O	O	
35	0h1D23	Input constant setting5	Void Para5	-9999-9999	0	X/A	O	O	
36	0h1D24	Input constant setting6	Void Para6	-9999-9999	0	X/A	O	O	
37	0h1D25	Input constant setting7	Void Para7	-9999-9999	0	X/A	O	O	
38	0h1D26	Input constant setting8	Void Para8	-9999-9999	0	X/A	O	O	
39	0h1D27	Input constant setting9	Void Para9	-9999-9999	0	X/A	O	O	
40	0h1D28	Input constant setting10	Void Para10	-9999-9999	0	X/A	O	O	
41	0h1D29	Input constant setting11	Void Para11	-9999-9999	0	X/A	O	O	
42	0h1D2A	Input constant setting12	Void Para12	-9999-9999	0	X/A	O	O	
43	0h1D2B	Input constant setting13	Void Para13	-9999-9999	0	X/A	O	O	
44	0h1D2C	Input constant setting14	Void Para14	-9999-9999	0	X/A	O	O	
45	0h1D2D	Input constant setting15	Void Para15	-9999-9999	0	X/A	O	O	
46	0h1D2E	Input constant setting16	Void Para16	-9999-9999	0	X/A	O	O	
47	0h1D2F	Input constant setting17	Void Para17	-9999-9999	0	X/A	O	O	
48	0h1D30	Input constant setting18	Void Para18	-9999-9999	0	X/A	O	O	
49	0h1D31	Input constant setting19	Void Para19	-9999-9999	0	X/A	O	O	
50	0h1D32	Input constant setting20	Void Para20	-9999-9999	0	X/A	O	O	
51	0h1D33	Input constant setting21	Void Para21	-9999-9999	0	X/A	O	O	
52	0h1D34	Input constant setting22	Void Para22	-9999-9999	0	X/A	O	O	
53	0h1D35	Input constant setting23	Void Para23	-9999-9999	0	X/A	O	O	
54	0h1D36	Input constant setting24	Void Para24	-9999-9999	0	X/A	O	O	
55	0h1D37	Input constant setting25	Void Para25	-9999-9999	0	X/A	O	O	
56	0h1D38	Input constant setting26	Void Para26	-9999-9999	0	X/A	O	O	
57	0h1D39	Input constant setting27	Void Para27	-9999-9999	0	X/A	O	O	

Code	Comm. Address	Name	LCD Display	Setting Range	Initial Value	Property*	V/F	SL	Ref.
58	0h1D3A	Input constant setting28	Void Para28	-9999-9999	0	X/A	O	O	
59	0h1D3B	Input constant setting29	Void Para29	-9999-9999	0	X/A	O	O	
60	0h1D3C	Input constant setting30	Void Para30	-9999-9999	0	X/A	O	O	
80	0h1D50S	Analog input 1	P2P In V1	0-12,000		-/A	O	O	
81	0h1D51	Analog input2	P2P In I2	-12,000-12,000		-/A	O	O	
82	0h1D52	Digital input	P2P In DI	0-0x7F		-/A	O	O	
85	0h1D55	Analog output	P2P OutAO1	0-10,000	0	X/A	O	O	
88	0h1D58	Digital output	P2P OutDO	0-0x03	0	X/A	O	O	

5.14 User Sequence Function group(UF)

This group appears when AP02 is set to 1 (Yes) or CM.95 is set to 2 (P2P Master). The parameter cannot be changed while the user sequence is running.

SL: Sensorless vector control function (dr.09)

***O/X:** Write-enabled during operation, **7/L/A:** keypad/LCD keypad/common

Code	Comm. Address	Name	LCD Display	Setting Range	Initial Value	Property*	V/F	SL	Ref.
00	-	Jump code	Jump Code	1-99	41	O/A	O	O	
01	0h1E01	User function1	User Func1	0	NOP	0:NOP	X/A	O	O
				1	ADD				
				2	SUB				
				3	ADDSUB				
				4	MIN				
				5	MAX				
				6	ABS				
				7	NEGATE				
				8	MPYDIV				
				9	REMAINDER				
				10	COMPARE-GT				
				11	COMPARE-GEQ				
				12	COMPARE-EQUAL				
				13	COMPARE-NEQUAL				
				14	TIMER				
				15	LIMIT				
				16	AND				
				17	OR				
18	XOR								

Code	Comm. Address	Name	LCD Display	Setting Range	Initial Value	Property*	V/F	SL	Ref.
				19 ANDOR					
				20 SWITCH					
				21 BITTEST					
				22 BITSET					
				23 BITCLEAR					
				24 LOWPASSFILTER					
				25 PL_CONTORL					
				26 PI_PROCESS					
				27 UPCOUNT					
				28 DOWNCOUNT					
02	0h1E02	User function input1-A	User Input1-A	0-0xFFFF	0	X/A	O	O	
03	0h1E03	User function input1-B	User Input1-B	0-0xFFFF	0	X/A	O	O	
04	0h1E04	User function input1-C	User Input1-C	0-0xFFFF	0	X/A	O	O	
05	0h1E05	User function output1	User Output1	-32767-32767	0	-/A	O	O	
06	0h1E06	User function 2	User Func2	0 NOP	0:NOP	X/A	O	O	
				1 ADD					
				2 SUB					
				3 ADDSUB					
				4 MIN					
				5 MAX					
				6 ABS					
				7 NEGATE					
				8 MPYDIV					
				9 REMAINDER					
				10 COMPARE-GT					
				11 COMPARE-GEQ					
				12 COMPARE-EQUAL					
				13 COMPARE-NEQUAL					
				14 TIMER					
				15 LIMIT					
				16 AND					
				17 OR					
				18 XOR					
				19 ANDOR					
				20 SWITCH					
				21 BITTEST					
				22 BITSET					
				23 BITCLEAR					

Chapter 5. Table of Functions

Code	Comm. Address	Name	LCD Display	Setting Range	Initial Value	Property*	V/F	SL	Ref.
				24	LOWPASSFILTER				
				25	PI_CONTORL				
				26	PI_PROCESS				
				27	UPCOUNT				
				28	DOWNCOUNT				
07	0h1E07	User function input2-A	User Input2-A	0-0xFFFF	0	X/A	O	O	
08	0h1E08	User function input2-B	User Input2-B	0-0xFFFF	0	X/A	O	O	
09	0h1E09	User function input2-C	User Input2-C	0-0xFFFF	0	X/A	O	O	
10	0h1E0A	User function output2	User Output2	-32767-32767	0	-/A	O	O	
11	0h1E0B	User function3	User Func3	0	NOP	0:NOP	X/A	O	O
				1	ADD				
				2	SUB				
				3	ADDSUB				
				4	MIN				
				5	MAX				
				6	ABS				
				7	NEGATE				
				8	MPYDIV				
				9	REMAINDER				
				10	COMPARE-GT				
				11	COMPARE-GEQ				
				12	COMPARE-EQUAL				
				13	COMPARE-NEQUAL				
				14	TIMER				
				15	LIMIT				
				16	AND				
				17	OR				
				18	XOR				
				19	ANDOR				
				20	SWITCH				
				21	BITTEST				
				22	BITSET				
				23	BITCLEAR				
				24	LOWPASSFILTER				
				25	PI_CONTORL				
				26	PI_PROCESS				
				27	UPCOUNT				
				28	DOWNCOUNT				

Code	Comm. Address	Name	LCD Display	Setting Range	Initial Value	Property*	V/F	SL	Ref.
12	0h1E0C	User function input3-A	User Input3-A	0-0xFFFF	0	X/A	O	O	
13	0h1E0D	User function input3-B	User Input3-B	0-0xFFFF	0	X/A	O	O	
14	0h1E0E	User function input3-C	User Input3-C	0-0xFFFF	0	X/A	O	O	
15	0h1E0F	User function output3	User Output3	-32767-32767	0	-/A	O	O	
16	0h1E10	User function4	User Func4	0	NOP	0:NOP	X/A	O	O
				1	ADD				
				2	SUB				
				3	ADDSUB				
				4	MIN				
				5	MAX				
				6	ABS				
				7	NEGATE				
				8	MPYDIV				
				9	REMAINDER				
				10	COMPARE-GT				
				11	COMPARE-GEQ				
				12	COMPARE-EQUAL				
				13	COMPARE-NEQUAL				
				14	TIMER				
				15	LIMIT				
				16	AND				
				17	OR				
				18	XOR				
				19	ANDOR				
				20	SWITCH				
				21	BITTEST				
				22	BITSET				
				23	BITCLEAR				
				24	LOWPASSFILTER				
				25	PI_CONTORL				
				26	PI_PROCESS				
				27	UPCOUNT				
				28	DOWNCOUNT				
17	0h1E11	User function input4-A	User Input4-A	0-0xFFFF	0	X/A	O	O	
18	0h1E12	User function input4-B	User Input4-B	0-0xFFFF	0	X/A	O	O	
19	0h1E13	User function input4-C	User Input4-C	0-0xFFFF	0	X/A	O	O	

Chapter 5. Table of Functions

Code	Comm. Address	Name	LCD Display	Setting Range	Initial Value	Property*	V/F	SL	Ref.
20	0h1E14	User function output4	User Output4	-32767-32767	0	-/A	O	O	
21	0h1E15	User function5	User Func5	0	NOP	0:NOP	X/A	O	O
1				ADD					
2				SUB					
3				ADDSUB					
4				MIN					
5				MAX					
6				ABS					
7				NEGATE					
8				MPYDIV					
9				REMAINDER					
10				COMPARE-GT					
11				COMPARE-GEQ					
12				COMPARE-EQUAL					
13				COMPARE-NEQUAL					
14				TIMER					
15				LIMIT					
16				AND					
17				OR					
18				XOR					
19				ANDOR					
20				SWITCH					
21				BITTEST					
22				BITSET					
23				BITCLEAR					
24				LOWPASSFILTER					
25				PI_CONTORL					
26				PI_PROCESS					
27				UPCOUNT					
28	DOWNCOUNT								
22	0h1E16	User function input5-A	User Input5-A	0-0xFFFF	0	X/A	O	O	
23	0h1E17	User function input5-B	User Input5-B	0-0xFFFF	0	X/A	O	O	
24	0h1E18	User function input5-C	User Input5-C	0-0xFFFF	0	X/A	O	O	
25	0h1E19	User function output5	User Output5	-32767-32767	0	-/A	O	O	
26	0h1E1A	User function6	User Func6	0	NOP	0:NOP	X/A	O	O
1				ADD					
2				SUB					
3				ADDSUB					

Code	Comm. Address	Name	LCD Display	Setting Range	Initial Value	Property*	V/F	SL	Ref.
				4	MIN				
				5	MAX				
				6	ABS				
				7	NEGATE				
				8	MPYDIV				
				9	REMAINDER				
				10	COMPARE-GT				
				11	COMPARE-GEQ				
				12	COMPARE-EQUAL				
				13	COMPARE-NEQUAL				
				14	TIMER				
				15	LIMIT				
				16	AND				
				17	OR				
				18	XOR				
				19	ANDOR				
				20	SWITCH				
				21	BITTEST				
				22	BITSET				
				23	BITCLEAR				
				24	LOWPASSFILTER				
				25	PI_CONTORL				
				26	PI_PROCESS				
				27	UPCOUNT				
				28	DOWNCOUNT				
27	0h1E1B	User function input6-A	User Input6-A	0-0xFFFF		0	X/A	O	O
28	0h1E1C	User function input6-B	User Input6-B	0-0xFFFF		0	X/A	O	O
29	0h1E1D	User function input6-C	User Input6-C	0-0xFFFF		0	X/A	O	O
30	0h1E1E	User function output6	User Output6	-32767-32767		0	-/A	O	O
31	0h1E1F	User function7	User Func7	0	NOP	0:NOP	X/A	O	O
1				ADD					
2				SUB					
3				ADDSUB					
4				MIN					
5				MAX					
6				ABS					
7				NEGATE					

Chapter 5. Table of Functions

Code	Comm. Address	Name	LCD Display	Setting Range	Initial Value	Property*	V/F	SL	Ref.	
				8	MPYDIV					
				9	REMAINDER					
				10	COMPARE-GT					
				11	COMPARE-GEQ					
				12	COMPARE-EQUAL					
				13	COMPARE-					
				14	TIMER					
				15	LIMIT					
				16	AND					
				17	OR					
				18	XOR					
				19	ANDOR					
				20	SWITCH					
				21	BITTEST					
				22	BITSET					
				23	BITCLEAR					
				24	LOWPASSFILTER					
				25	PI_CONTORL					
				26	PI_PROCESS					
				27	UPCOUNT					
				28	DOWNCOUNT					
32	0h1E20	User function input7-A	User Input7-A	0-0xFFFF		0	X/A	O	O	
33	0h1E21	User function input7-B	User Input7-B	0-0xFFFF		0	X/A	O	O	
34	0h1E22	User function input7-C	User Input7-C	0-0xFFFF		0	X/A	O	O	
35	0h1E23	User function output7	User Output7	-32767-32767		0	-/A	O	O	
36	0h1E24	User function8	User Func8	0	NOP	0:NOP	X/A	O	O	
1				ADD						
2				SUB						
3				ADDSUB						
4				MIN						
5				MAX						
6				ABS						
7				NEGATE						
8				MPYDIV						
9				REMAINDER						
10				COMPARE-GT						
11				COMPARE-GEQ						
12				COMPARE-EQUAL						

Code	Comm. Address	Name	LCD Display	Setting Range	Initial Value	Property*	V/F	SL	Ref.
				13 COMPARE-NEQUAL					
				14 TIMER					
				15 LIMIT					
				16 AND					
				17 OR					
				18 XOR					
				19 ANDOR					
				20 SWITCH					
				21 BITTEST					
				22 BITSET					
				23 BITCLEAR					
				24 LOWPASSFILTER					
				25 PI_CONTORL					
				26 PI_PROCESS					
				27 UPCOUNT					
				28 DOWNCOUNT					
37	0h1E25	User function input8-A	User Input8-A	0-0xFFFF	0	X/A	O	O	
38	0h1E26	User function input8-B	User Input8-B	0-0xFFFF	0	X/A	O	O	
39	0h1E27	User function input8-C	User Input8-C	0-0xFFFF	0	X/A	O	O	
40	0h1E28	User function output8	User Output8	-32767-32767	0	-/A	O	O	
41	0h1E29	User function9	User Func9	0 NOP	0:NOP	X/A	O	O	
				1 ADD					
				2 SUB					
				3 ADDSUB					
				4 MIN					
				5 MAX					
				6 ABS					
				7 NEGATE					
				8 MPYDIV					
				9 REMAINDER					
				10 COMPARE-GT					
				11 COMPARE-GEQ					
				12 COMPARE-EQUAL					
				13 COMPARE-NEQUAL					
				14 TIMER					
				15 LIMIT					
				16 AND					

Chapter 5. Table of Functions

Code	Comm. Address	Name	LCD Display	Setting Range	Initial Value	Property*	V/F	SL	Ref.
				17 OR					
				18 XOR					
				19 ANDOR					
				20 SWITCH					
				21 BITTEST					
				22 BITSET					
				23 BITCLEAR					
				24 LOWPASSFILTER					
				25 PI_CONTORL					
				26 PI_PROCESS					
				27 UPCOUNT					
				28 DOWNCOUNT					
42	0h1E2A	User function input9-A	User Input9-A	0-0xFFFF	0	X/A	O	O	
43	0h1E2B	User function input9-B	User Input9-B	0-0xFFFF	0	X/A	O	O	
44	0h1E2C	User function input9-C	User Input9-C	0-0xFFFF	0	X/A	O	O	
45	0h1E2D	User function output9	User Output9	-32767-32767	0	-/A	O	O	
46	0h1E2E	User function10	User Func10	0	NOP	0:NOP	X/A	O	O
1				ADD					
2				SUB					
3				ADDSUB					
4				MIN					
5				MAX					
6				ABS					
7				NEGATE					
8				MPYDIV					
9				REMAINDER					
10				COMPARE-GT					
11				COMPARE-GEQ					
12				COMPARE-EQUAL					
13				COMPARE-NEQUAL					
14				TIMER					
15				LIMIT					
16				AND					
17				OR					
18				XOR					
19				ANDOR					
20				SWITCH					
21	BITTEST								

Code	Comm. Address	Name	LCD Display	Setting Range	Initial Value	Property*	V/F	SL	Ref.
				22 BITSET					
				23 BITCLEAR					
				24 LOWPASSFILTER					
				25 PI_CONTORL					
				26 PI_PROCESS					
				27 UPCOUNT					
				28 DOWNCOUNT					
47	0h1E2F	User function input10-A	User Input10-A	0-0xFFFF	0	X/A	O	O	
48	0h1E30	User function input10-B	User Input10-B	0-0xFFFF	0	X/A	O	O	
49	0h1E31	User function input10-C	User Input10-C	0-0xFFFF	0	X/A	O	O	
50	0h1E32	User function output10	User Output10	-32767-32767	0	-/A	O	O	
51	0h1E33	User function11	User Func11	0 NOP	0:NOP	X/A	O	O	
1 ADD									
2 SUB									
3 ADDSUB									
4 MIN									
5 MAX									
6 ABS									
7 NEGATE									
8 MPYDIV									
9 REMAINDER									
10 COMPARE-GT									
11 COMPARE-GEQ									
12 COMPARE-EQUAL									
13 COMPARE-NEQUAL									
14 TIMER									
15 LIMIT									
16 AND									
17 OR									
18 XOR									
19 ANDOR									
20 SWITCH									
21 BITTEST									
22 BITSET									
23 BITCLEAR									
24 LOWPASSFILTER									
25 PI_CONTORL									
26 PI_PROCESS									

Chapter 5. Table of Functions

Code	Comm. Address	Name	LCD Display	Setting Range	Initial Value	Property*	V/F	SL	Ref.
				27	UPCOUNT				
				28	DOWNCOUNT				
52	0h1E34	User function input11-A	User Input11-A	0-0xFFFF	0	X/A	O	O	
53	0h1E35	User function input11-B	User Input11-B	0-0xFFFF	0	X/A	O	O	
54	0h1E36	User function input11-C	User Input11-C	0-0xFFFF	0	X/A	O	O	
55	0h1E37	User function output11	User Output11	-32767-32767	0	-/A	O	O	
56	0h1E38	User function12	User Func12	0	NOP	0:NOP	X/A	O	O
1				ADD					
2				SUB					
3				ADDSUB					
4				MIN					
5				MAX					
6				ABS					
7				NEGATE					
8				MPYDIV					
9				REMAINDER					
10				COMPARE-GT					
11				COMPARE-GEQ					
12				COMPARE-EQUAL					
13				COMPARE-NEQUAL					
14				TIMER					
15				LIMIT					
16				AND					
17				OR					
18				XOR					
19				ANDOR					
20				SWITCH					
21				BITTEST					
22				BITSET					
23				BITCLEAR					
24				LOWPASSFILTER					
25				PI_CONTORL					
26				PI_PROCESS					
27				UPCOUNT					
28	DOWNCOUNT								
57	0h1E39	User function input12-A	User Input12-A	0-0xFFFF	0	X/A	O	O	
58	0h1E3A	User function	User	0-0xFFFF	0	X/A	O	O	

Code	Comm. Address	Name	LCD Display	Setting Range	Initial Value	Property*	V/F	SL	Ref.
		input12-B	Input12-B						
59	0h1E3B	User function input12-C	User Input12-C	0-0xFFFF	0	X/A	O	O	
60	0h1E3C	User function output12	User Output12	-32767-32767	0	-/A	O	O	
61	0h1E3D	User function13	User Func13	0	NOP	0:NOP	X/A	O	O
1				ADD					
2				SUB					
3				ADDSUB					
4				MIN					
5				MAX					
6				ABS					
7				NEGATE					
8				MPYDIV					
9				REMAINDER					
10				COMPARE-GT					
11				COMPARE-GEQ					
12				COMPARE-EQUAL					
13				COMPARE-NEQUAL					
14				TIMER					
15				LIMIT					
16				AND					
17				OR					
18				XOR					
19				ANDOR					
20				SWITCH					
21				BITTEST					
22				BITSET					
23				BITCLEAR					
24				LOWPASSFILTER					
25				PI_CONTORL					
26				PI_PROCESS					
27				UPCOUNT					
28				DOWNCOUNT					
62	0h1E3E	User function input13-A	User Input13-A	0-0xFFFF	0	X/A	O	O	
63	0h1E3F	User function input13-B	User Input13-B	0-0xFFFF	0	X/A	O	O	
64	0h1E40	User function input13-C	User Input13-C	0-0xFFFF	0	X/A	O	O	
65	0h1E41	User function output13	User Output13	-32767-32767	0	-/A	O	O	

Chapter 5. Table of Functions

Code	Comm. Address	Name	LCD Display	Setting Range	Initial Value	Property*	V/F	SL	Ref.
66	0h1E42	User function14	User Func14	0	NOP	0:NOP	X/A	O	O
				1	ADD				
				2	SUB				
				3	ADDSUB				
				4	MIN				
				5	MAX				
				6	ABS				
				7	NEGATE				
				8	MPYDIV				
				9	REMAINDER				
				10	COMPARE-GT				
				11	COMPARE-GEQ				
				12	COMPARE-EQUAL				
				13	COMPARE-NEQUAL				
				14	TIMER				
				15	LIMIT				
				16	AND				
				17	OR				
				18	XOR				
				19	ANDOR				
				20	SWITCH				
				21	BITTEST				
				22	BITSET				
				23	BITCLEAR				
				24	LOWPASSFILTER				
				25	PI_CONTORL				
				26	PI_PROCESS				
				27	UPCOUNT				
28	DOWNCOUNT								
67	0h1E43	User function input14-A	User Input14-A	0-0xFFFF	0	X/A	O	O	
68	0h1E44	User function input14-B	User Input14-B	0-0xFFFF	0	X/A	O	O	
69	0h1E45	User function input14-C	User Input14-C	0-0xFFFF	0	X/A	O	O	
70	0h1E46	User function output14	User Output14	-32767-32767	0	-/A	O	O	
71	0h1E47	User function15	User Func15	0	NOP	0:NOP	X/A	O	O
				1	ADD				
				2	SUB				
				3	ADDSUB				
				4	MIN				

Code	Comm. Address	Name	LCD Display	Setting Range	Initial Value	Property*	V/F	SL	Ref.
				5 MAX					
				6 ABS					
				7 NEGATE					
				8 MPYDIV					
				9 REMAINDER					
				10 COMPARE-GT					
				11 COMPARE-GEQ					
				12 COMPARE-EQUAL					
				13 COMPARE-NEQUAL					
				14 TIMER					
				15 LIMIT					
				16 AND					
				17 OR					
				18 XOR					
				19 ANDOR					
				20 SWITCH					
				21 BITTEST					
				22 BITSET					
				23 BITCLEAR					
				24 LOWPASSFILTER					
				25 PI_CONTORL					
				26 PI_PROCESS					
				27 UPCOUNT					
				28 DOWNCOUNT					
72	0h1E48	User function input15-A	User Input15-A	0-0xFFFF	0	X/A	O	O	
73	0h1E49	User function input15-B	User Input15-B	0-0xFFFF	0	X/A	O	O	
74	0h1E4A	User function input15-C	User Input15-C	0-0xFFFF	0	X/A	O	O	
75	0h1E4B	User function output15	User Output15	-32767-32767	0	-/A	O	O	
76	0h1E4C	User function 16	User Func16	0 NOP	0:NOP	X/A	O	O	
				1 ADD					
				2 SUB					
				3 ADDSUB					
				4 MIN					
				5 MAX					
				6 ABS					
				7 NEGATE					
				8 MPYDIV					
				9 REMAINDER					

Chapter 5. Table of Functions

Code	Comm. Address	Name	LCD Display	Setting Range	Initial Value	Property*	V/F	SL	Ref.	
				10	COMPARE-GT					
				11	COMPARE-GEQ					
				12	COMPARE-EQUAL					
				13	COMPARE-NEQUAL					
				14	TIMER					
				15	LIMIT					
				16	AND					
				17	OR					
				18	XOR					
				19	ANDOR					
				20	SWITCH					
				21	BITTEST					
				22	BITSET					
				23	BITCLEAR					
				24	LOWPASSFILTER					
				25	PI_CONTORL					
				26	PI_PROCESS					
				27	UPCOUNT					
				28	DOWNCOUNT					
77	0h1E4D	User function input16-A	User Input16-A	0-0xFFFF		0	X/A	O	O	
78	0h1E4E	User function input16-B	User Input16-B	0-0xFFFF		0	X/A	O	O	
79	0h1E4F	User function input16-C	User Input16-C	0-0xFFFF		0	X/A	O	O	
80	0h1E50	User function output16	User Output16	-32767-32767		0	-/A	O	O	
81	0h1E51	User function 17	User Func17	0	NOP	0:NOP	X/A	O	O	
1				ADD						
2				SUB						
3				ADDSUB						
4				MIN						
5				MAX						
6				ABS						
7				NEGATE						
8				MPYDIV						
9				REMAINDER						
10				COMPARE-GT						
11				COMPARE-GEQ						
12				COMPARE-EQUAL						
13				COMPARE-NEQUAL						

Code	Comm. Address	Name	LCD Display	Setting Range	Initial Value	Property*	V/F	SL	Ref.
				14	TIMER				
				15	LIMIT				
				16	AND				
				17	OR				
				18	XOR				
				19	ANDOR				
				20	SWITCH				
				21	BITTEST				
				22	BITSET				
				23	BITCLEAR				
				24	LOWPASSFILTER				
				25	PI_CONTORL				
				26	PI_PROCESS				
				27	UPCOUNT				
				28	DOWNCOUNT				
82	0h1E52	User function input17-A	User Input17-A	0-0xFFFF		0	X/A	O	O
83	0h1E53	User function input17-B	User Input17-B	0-0xFFFF		0	X/A	O	O
84	0h1E54	User function input17-C	User Input17-C	0-0xFFFF		0	X/A	O	O
85	0h1E55	User function output17	User Output17	-32767-32767		0	-/A	O	O
86	0h1E56	User function 18	User Func18	0	NOP	0:NOP	X/A	O	O
1				ADD					
2				SUB					
3				ADDSUB					
4				MIN					
5				MAX					
6				ABS					
7				NEGATE					
8				MPYDIV					
9				REMAINDER					
10				COMPARE-GT					
11				COMPARE-GEQ					
12				COMPARE-EQUAL					
13				COMPARE-NEQUAL					
14				TIMER					
15				LIMIT					
16				AND					
17				OR					
18	XOR								

Code	Comm. Address	Name	LCD Display	Setting Range	Initial Value	Property*	V/F	SL	Ref.
				19 ANDOR					
				20 SWITCH					
				21 BITTEST					
				22 BITSET					
				23 BITCLEAR					
				24 LOWPASSFILTER					
				25 PI_CONTORL					
				26 PI_PROCESS					
				27 UPCOUNT					
				28 DOWNCOUNT					
87	0h1E57	User function input18-A	User Input18-A	0-0xFFFF	0	X/A	O	O	
88	0h1E58	User function input18-B	User Input18-B	0-0xFFFF	0	X/A	O	O	
89	0h1E59	User function input18-C	User Input18-C	0-0xFFFF	0	X/A	O	O	
90	0h1E5A	User function output18	User Output18	-32767-32767	0	-/A	O	O	

5.15 Groups for LCD Keypad Only

5.15.1 Trip Mode (TRP Last-x)

Code	Name	LCD Display	Setting Range	Initial Value	Ref.
00	Trip type display	Trip Name(x)	-	-	-
01	Frequency reference at trip	Output Freq	-	-	-
02	Output current at trip	Output Current	-	-	-
03	Acceleration/Deceleration state at trip	Inverter State	-	-	-
04	DC section state	DCLink Voltage	-	-	-
05	NTC temperature	Temperature	-	-	-
06	Input terminal state 단자대	DI Status	-	0000 0000	-
07	Output terminal state	DO Status	-	000	-
08	Trip time after Power on	Trip On Time	-	0/00/00 00:00	-
09	Trip time after operation start	Trip Run Time	-	0/00/00 00:00	-
10					
10	Delete trip history	Trip Delete?	0	No	
			1	Yes	

5.15.2 Config Mode (CNF)

Code	Name	LCD Display	Setting Range		Initial Value	Ref.
00	Jump code	Jump Code	1-99		42	
01	Keypad language selection	Language Sel	0 : English		0 : English	
02	LCD constrast adjustment	LCD Contrast	-		-	
03	Multi keypad ID	Multi KPD ID	3-99		3	
10	Inverter S/W version	Inv S/W Ver	-		-	
11	LCD keypad S/W version	Keypad S/W Ver	-		-	
12	LCD keypad title version	KPD Title Ver	-		-	
20	Status window display item	Anytime Para	0	Frequency	0: Frequency	
21	Monitor mode display item1	Monitor Line-1	1	Speed	0: Frequency	
22	Monitor mode display item2	Monitor Line-2	2	Output Current	2:Output Current	
23	Monitor mode display item3	Monitor Line-3	3	Output Voltage	3:Output Voltage	
			4	Output Power		
			5	WHour Counter		
			6	DCLink Voltage		
			7	DI State		
			8	DO State		
			9	V1 Monitor(V)		
			10	V1 Monitor(%)		
			13	V2 Monitor(V)		
			14	V2 Monitor(%)		
			15	I2 Monitor(mA)		
			16	I2 Monitor(%)		
			17	PID Output		
			18	PID Ref Value		
19	PID Fdb Value					
20	Torque					
21	Torque Limit					
23	Speed Limit					
24	Monitor mode initialization	Mon Mode Init	0	No	0:No	
			1	Yes		
30	Option slot 1 type display	Option-1 Type	0	None	0:None	
31	Option slot 2 type display	Option-2 Type	6	Ethernet	0:None	
32	Option slot 3 type display	Option-3 Type	9	CANopen	0:None	
40	Parameter initialization	Parameter Init	0	No		
			1	All Grp		
			2	DRV Grp		
			3	BAS Grp		

Chapter 5. Table of Functions

Code	Name	LCD Display	Setting Range		Initial Value	Ref.
			4	ADV Grp		
			5	CON Grp		
			6	IN Grp		
			7	OUT Grp		
			8	COM Grp		
			9	APP Grp		
			12	PRT Grp		
			13	M2 Grp		
41	Display changed Parameter	Changed Para	0	View All	0:View All	
			1	View Changed		
42	Multi key item	Multi Key Sel	0	None	0:None	
			1	JOG Key		
			2	Local/Remote		
			3	UserGrp SelKey		
			4	Multi KPD		
43	Macro function item	Macro Select	0	None	0:None	
44	Trip history deletion	Erase All Trip	0	No	0:No	
			1	Yes		
45	User registration code deletion	UserGrp AllDel	0	No	0:No	
			1	Yes		
46	Read parameters	Parameter Read	0	No	0:No	
			1	Yes		
47	Write parameters	Parameter Write	0	No	0: No	
			1	Yes		
48	Save parameters	Parameter Save	0	No	0:No	
			1	Yes		
50	Hide parameter mode	View Lock Set	0-9999		Un-locked	
51	Password for hiding parameter mode	View Lock Pw	0-9999		Password	
52	Lock parameter edit	Key Lock Set	0-9999		Un-locked	
53	Password for locking parameter edit	Key Lock Pw	0-9999		Password	
60	Additional title update	Add Title Up	0	No	0:No	
			1	Yes		
61	Simple parameter setting	Easy Start On	0	No	1:Yes	
			1	Yes		
62	Power consumption initialization	WHCount Reset	0	No	0:No	
			1	Yes		
70	Accumulated inverter motion time	On-time	Year/month/day hour:minute		-	
71	Accumulated inverter operation time	Run-time	Year/month/day hour:minute		-	

Code	Name	LCD Display	Setting Range		Initial Value	Ref.
72	Accumulated inverter operation time initialization	Time Reset	0	No	0:No	
			1	Yes		
74	Accumulated cooling fan operation time	Fan Time	Year/month/day hour:minute		-	
75	Reset of accumulated cooling fan operation time	Fan Time Rst	0	No	0:No	
			1	Yes		

Warranty

Maker	LS ELECTRIC Co., Ltd.		Installation Date	
Model No.	S100 Extension I/O		Warranty Period	
Customer Information	Name			
	Address			
	Tel.			
Sales Office (Distributor)	Name			
	Address			
	Tel.			

Warranty period is 12 months after installation or 18 months after manufactured when the installation date is unidentified. However, the guarantee term may vary on the sales term.

IN-WARRANTY service information

If the defective part has been identified under normal and proper use within the guarantee term, contact your local authorized LS distributor or LS Service center.

OUT-OF WARRANTY service information

The guarantee will not apply in the following cases, even if the guarantee term has not expired.

Damage was caused by misuse, negligence or accident.

Damage was caused by abnormal voltage and peripheral devices' malfunction (failure).

Damage was caused by an earthquake, fire, flooding, lightning, or other natural calamities.

When LS nameplate is not attached.

When the warranty period has expired.